

Guia de instalação SAFECAR – Cofre Blindado BR262



SAFECAR

ESPECIALISTA CONTRA CRIMES AUTOMOTIVOS

Atenção



- A instalação deve ser feita somente por profissionais autorizados;
- Ligar o carro para garantir que não exista nenhuma luz indicando defeito no painel;
- Caso tenha alguma luz de defeito acesa, informe o cliente antes do início da instalação;
- Aguarde 15 minutos após o desligamento do veículo para iniciar o processo de instalação;
- Não desmonte qualquer peça do veículo que não apareça neste guia;
- Ao final da instalação devolva as chaves do veículo onde as pegou.

Componentes do Cofre Blindado

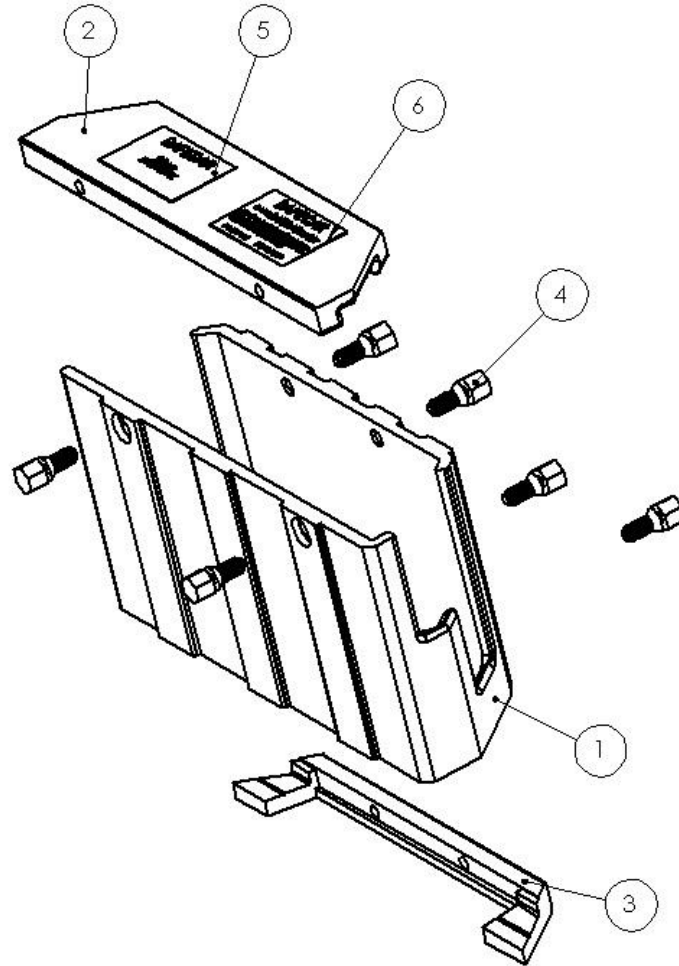

Nº DO ITEM	Nº DA PEÇA	QTD.
1	Caixa do cofre	1
2	Tampa do cofre	1
3	Trava do cofre	1
4	Parafuso especial	6
5	Etiqueta PRODUTO	1
6	Etiqueta SAFECAR	1

Instalação



1. Retire o conector **NEGATIVO** da bateria.

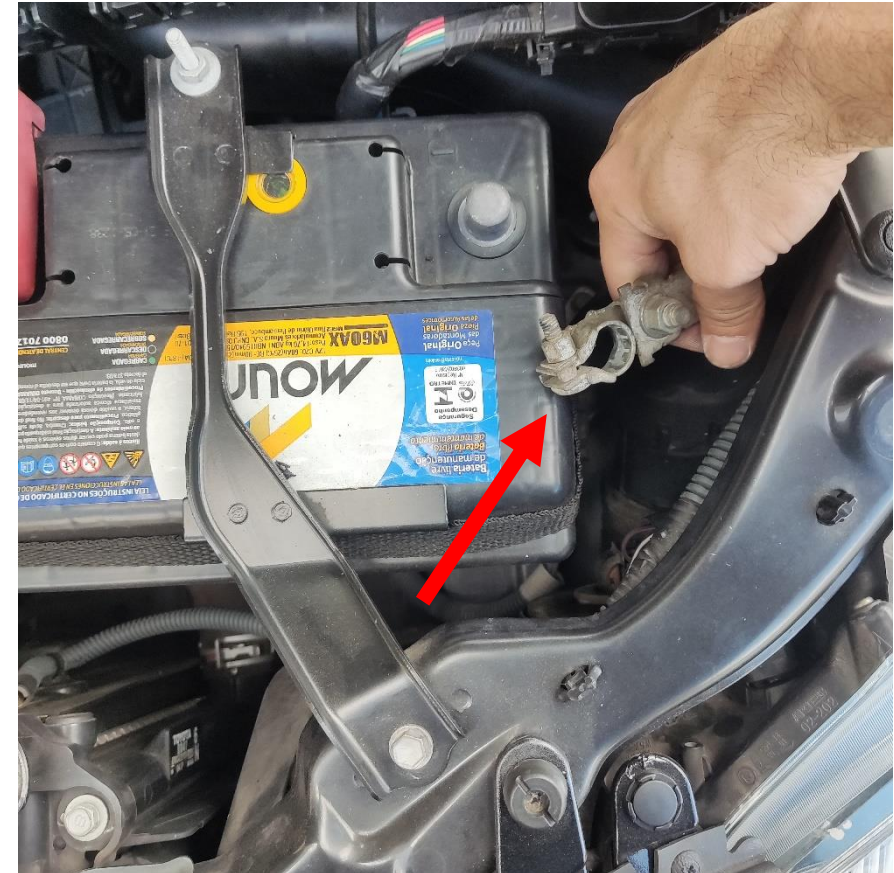

Instalação



2. Retire a tampa da caixa de fusível pressionando a trava, vide primeira imagem, desloque ela em direção à traseira do veículo para desencaixá-la..

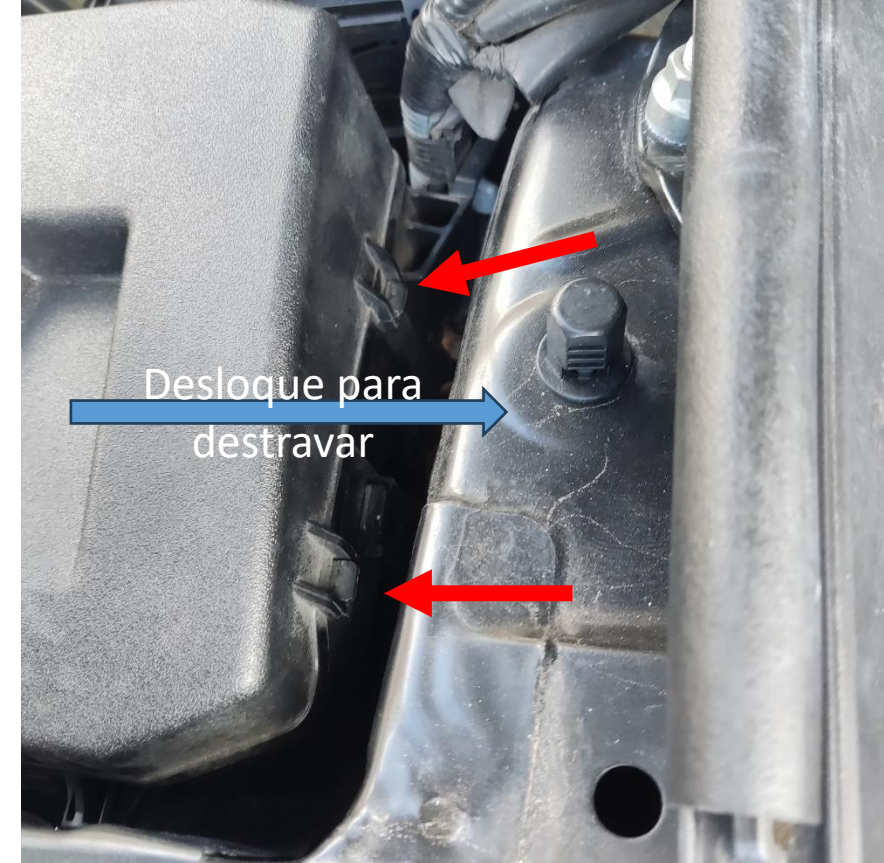

Instalação

3. Retire a tampa.

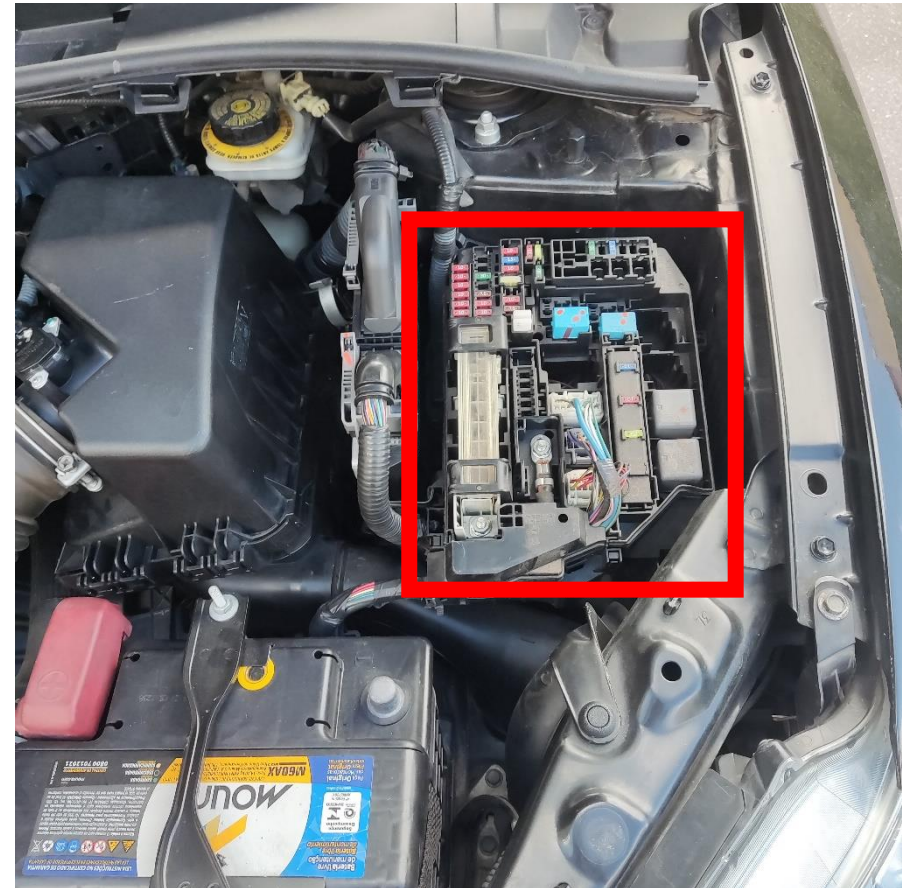

Instalação

4. Retire a mangueira da caixa de admissão de ar.

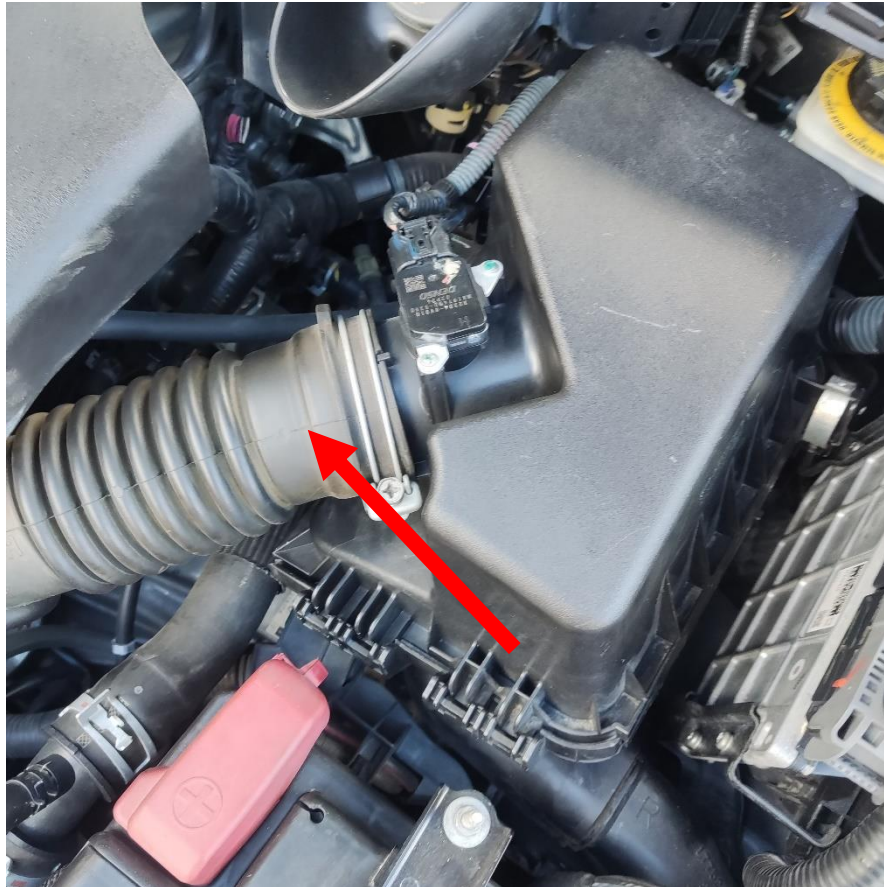

Instalação

5. Aperte o conector até escutar um click e puxe para cima o conector do sensor de ar.



Instalação



6. Na parte inferior do suporte do chicote do conector do campo 5 empurre a língua do suporte no sentido da traseira do carro puxando o suporte para cima.



Instalação

7. Solte a trava do lado direito da caixa de admissão de ar.



Instalação

8. Solte a trava do lado esquerdo da caixa de admissão de ar.

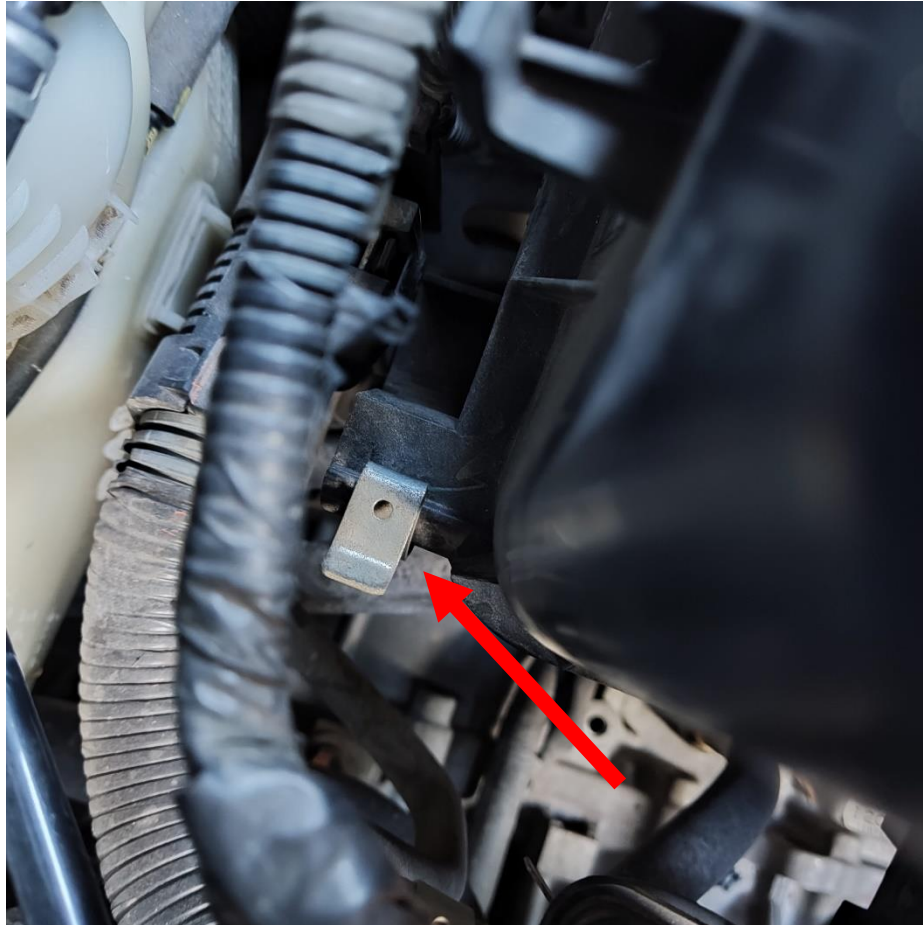

Instalação

9. Retire o filtro da caixa de admissão de ar.



Instalação



10. Retire o suporte do chicote do suporte da caixa de admissão puxando a língua dele e deslocando ele para cima

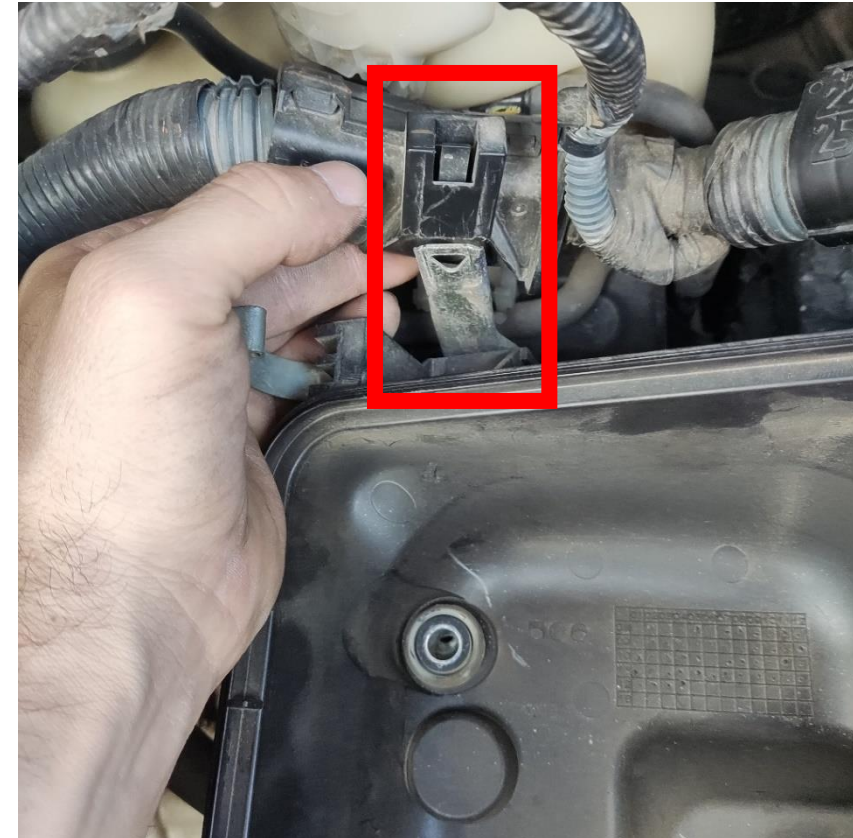

Instalação



11. Retire os parafusos da caixa de admissão para poder remove-la.

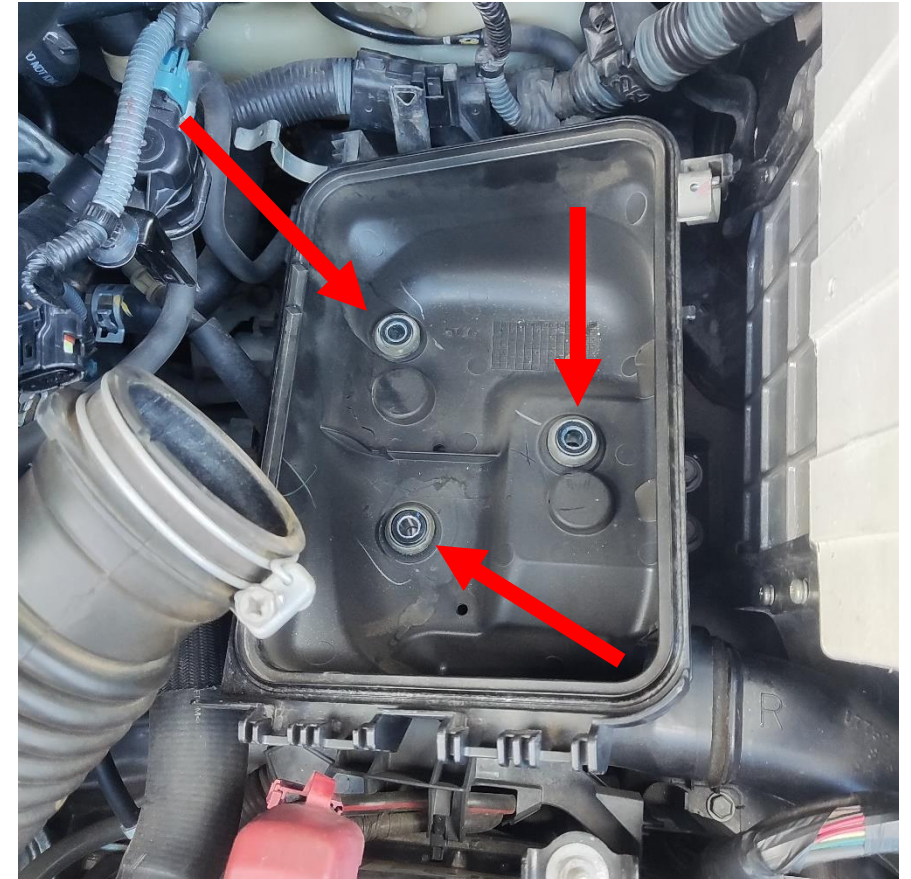
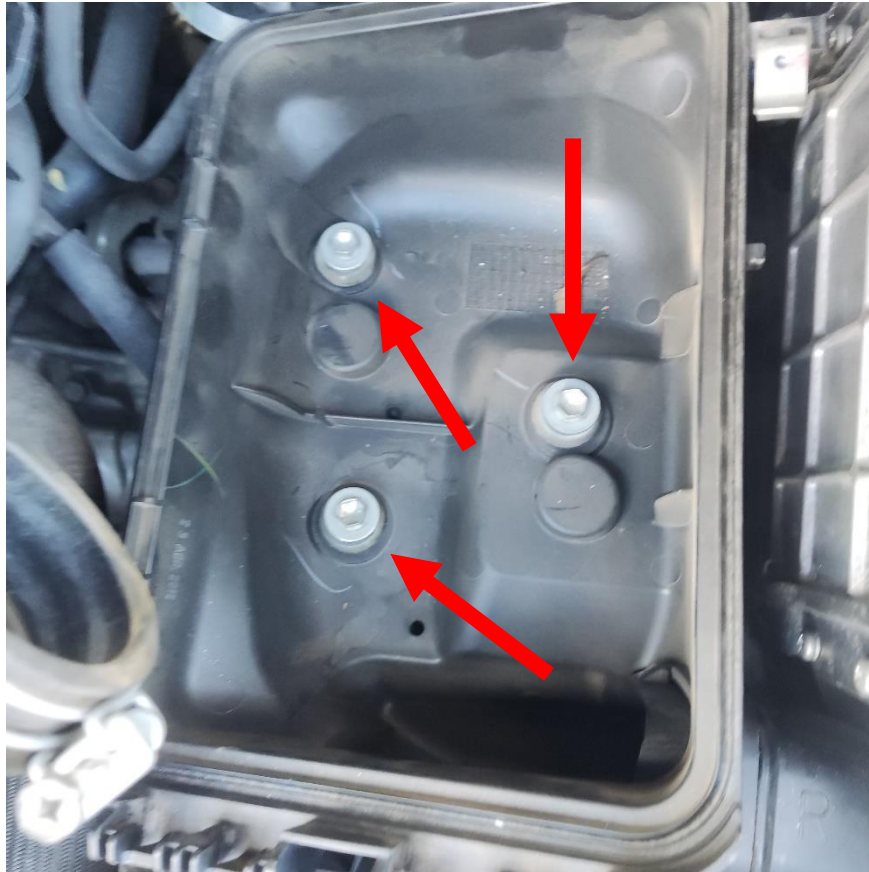

Instalação



12. Retire a caixa de admissão de ar.

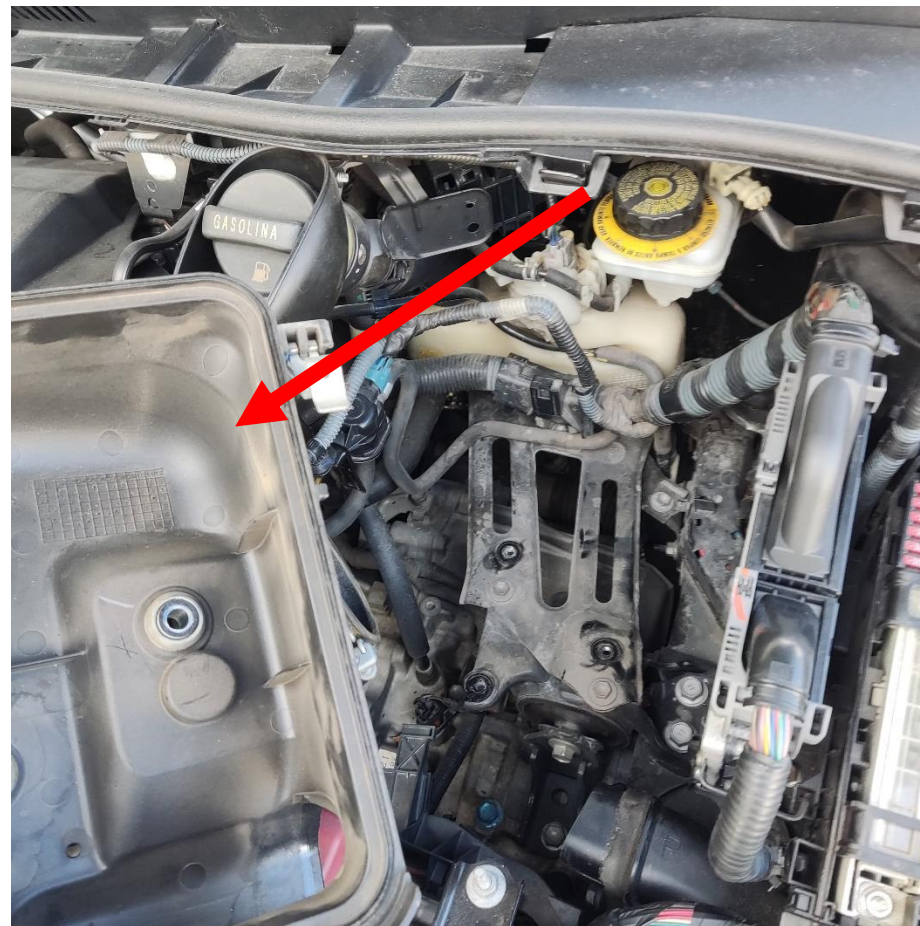

Instalação

13. Desencaixe o fixador do chicote do Módulo.

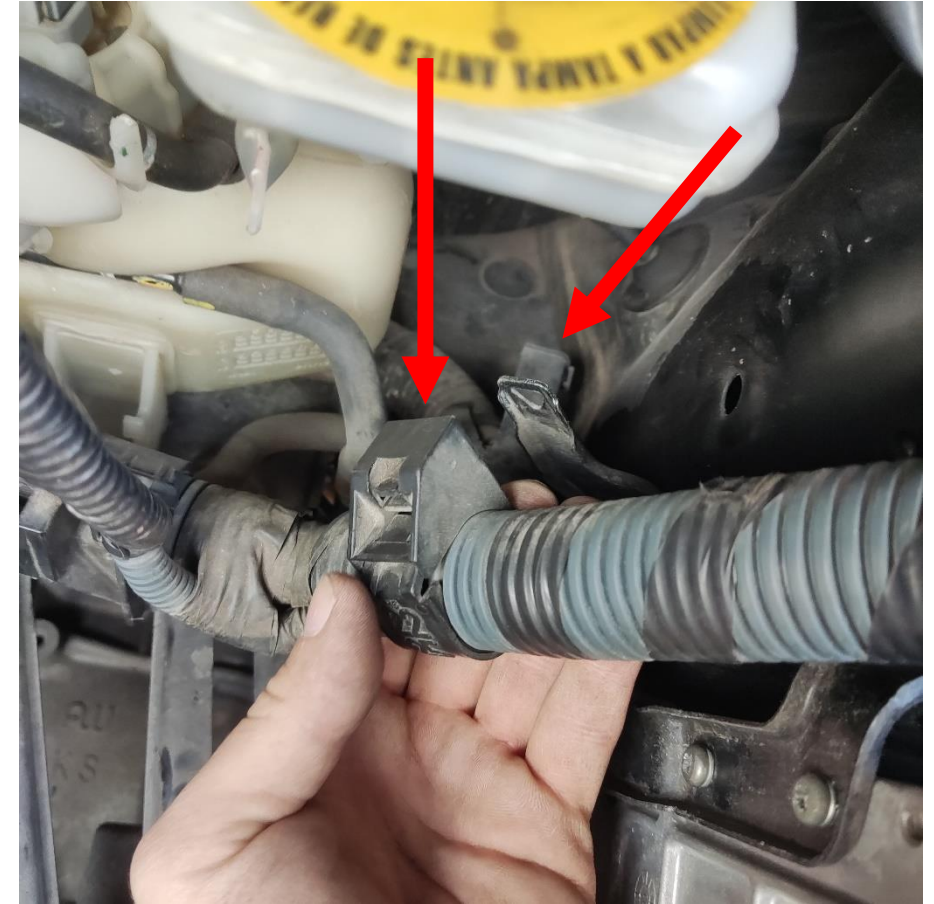

Instalação

14. Remova os parafusos que prendem o Módulo no suporte

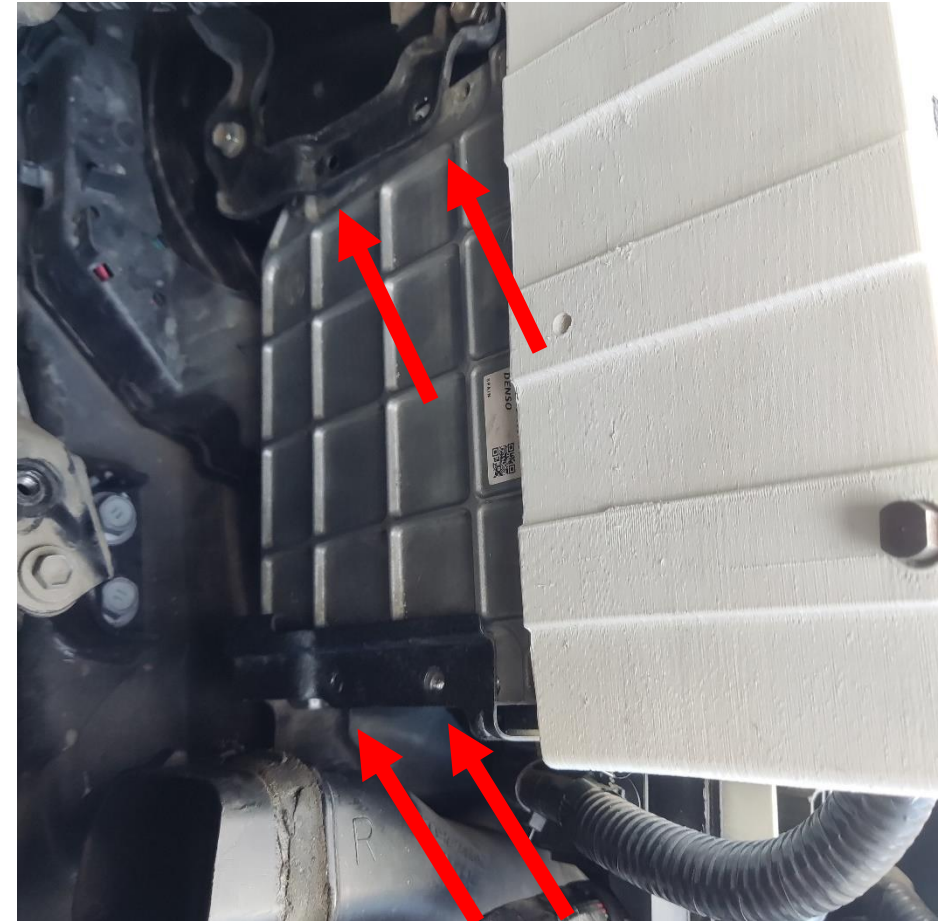
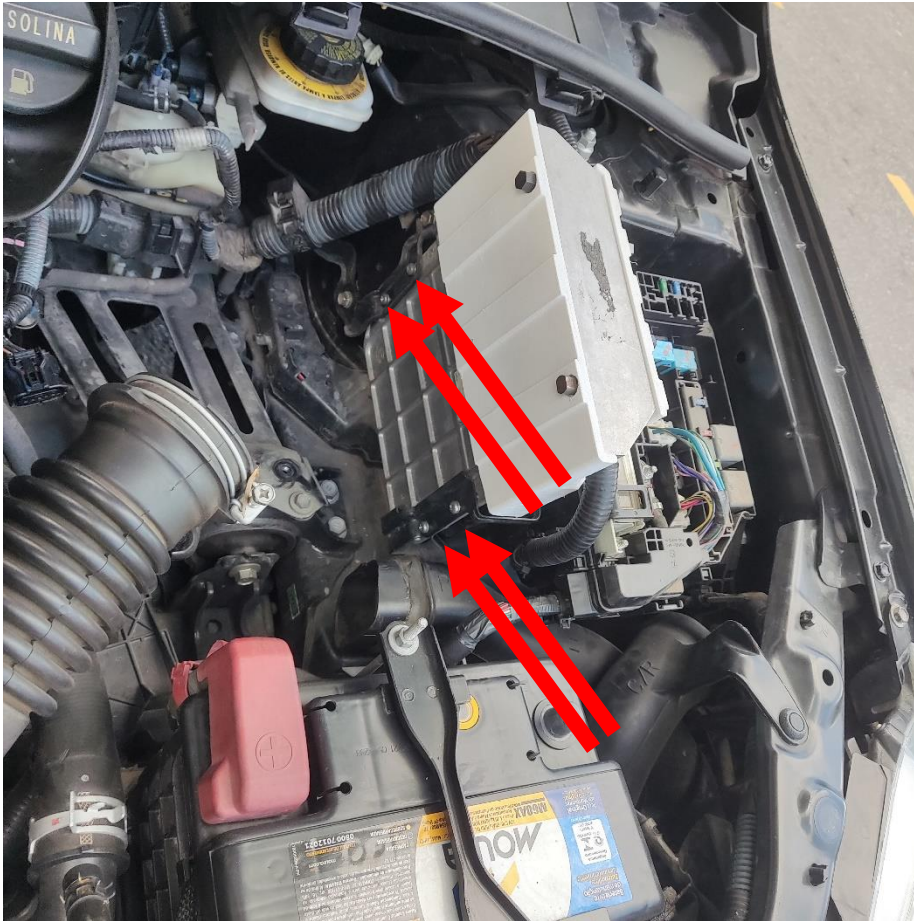

Instalação



15. Retire o suporte do módulo que fica fixado na caixa de roda do carro removendo os dois parafusos.

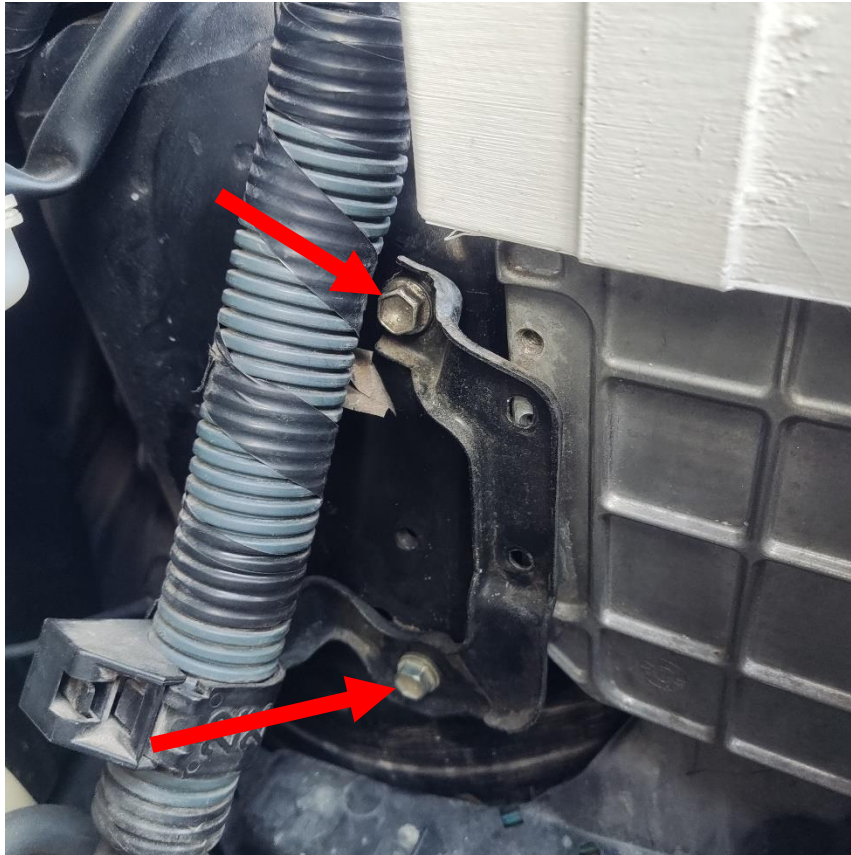

Instalação



16. Puxe o Módulo para fora do compartimento para instalar o cofre.

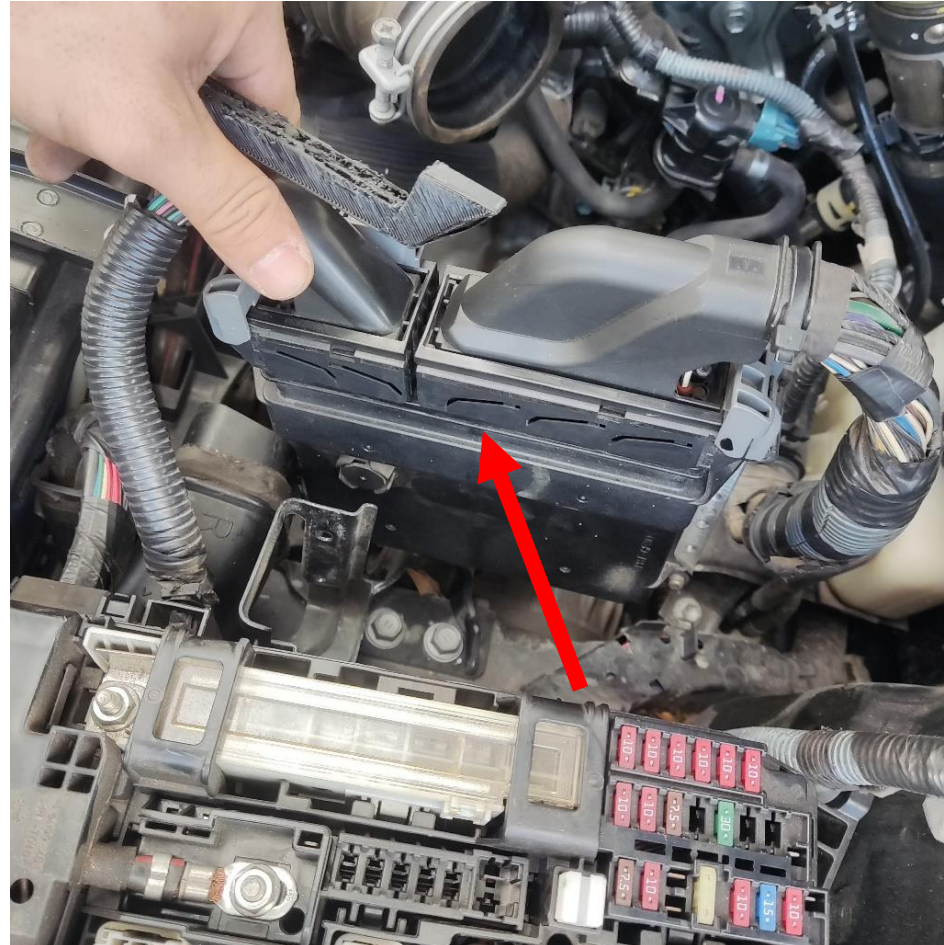

Instalação



17. Vista a caixa do cofre de baixo para cima no módulo conforme as imagens.

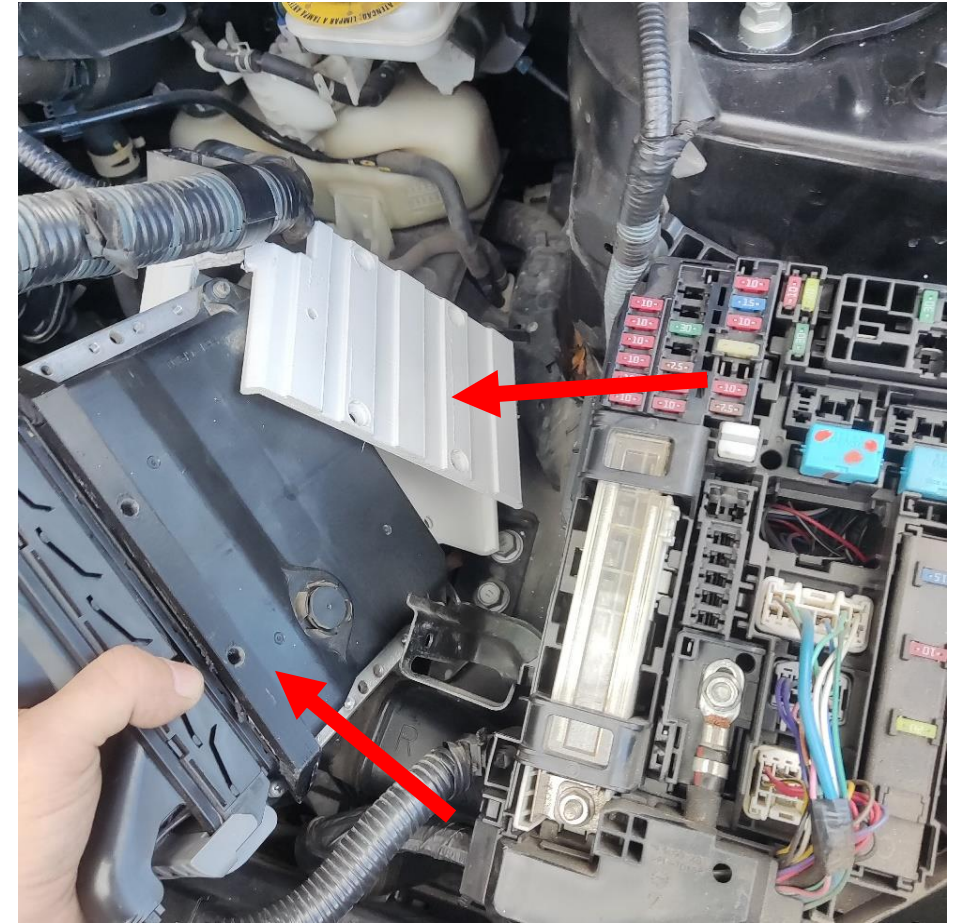
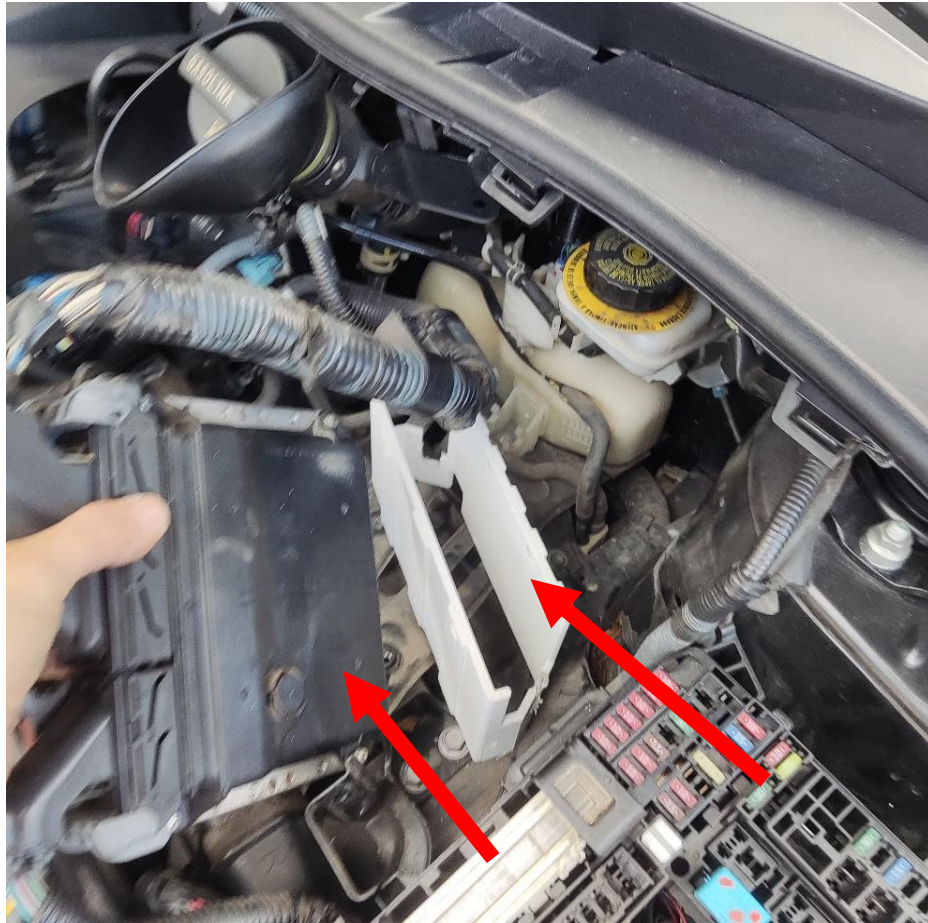

Instalação



18. Coloque a trava do cofre em baixo dos conectores e termine de vestir a caixa do cofre.

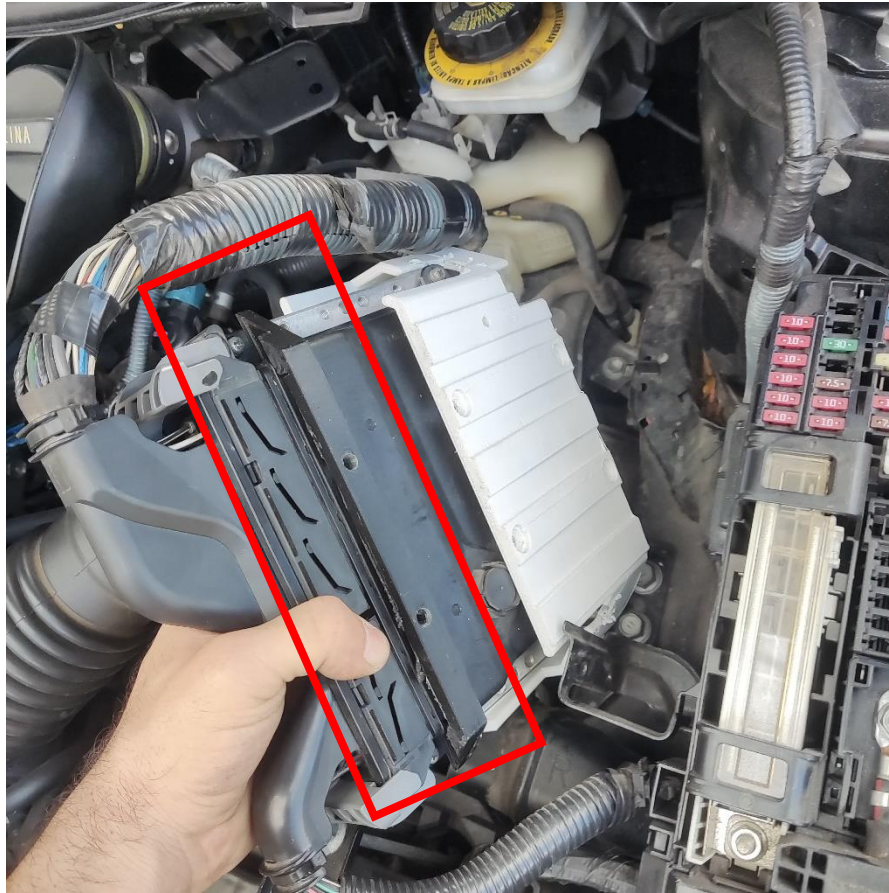

Instalação



19. Coloque manualmente os parafusos especiais fixando a caixa do cofre na trava. **NÃO QUEBRE A CABEÇA DOS PARAFUSOS**

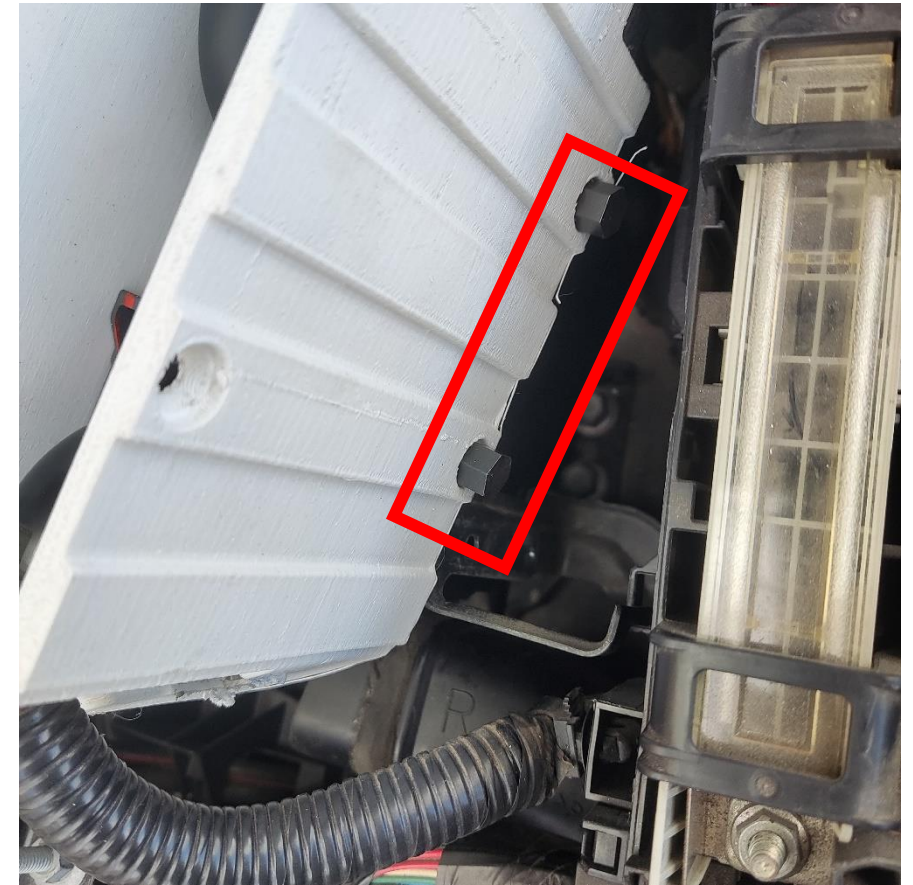
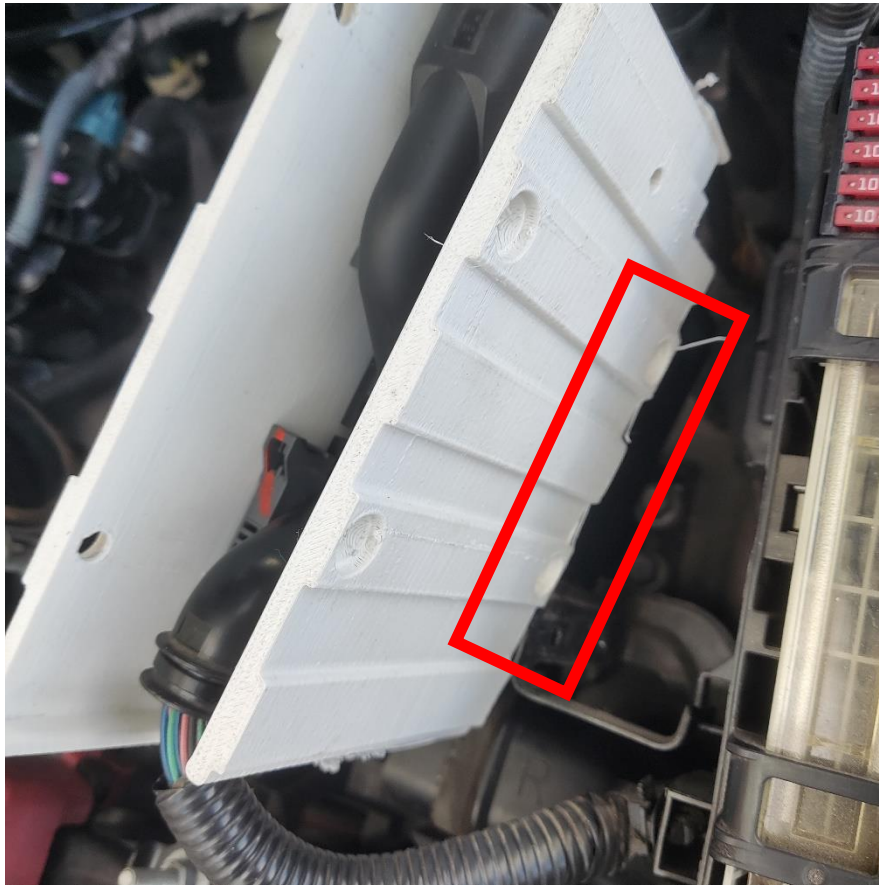

Instalação

20. Coloque a tampa no cofre e os parafusos especiais. **NÃO QUEBRE A CABEÇA**
DOS PARAFUSOS.

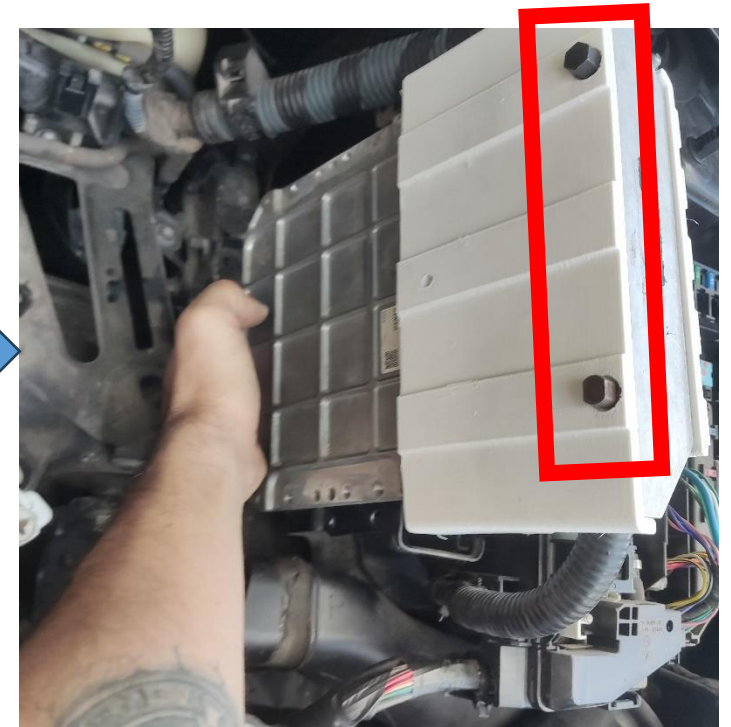
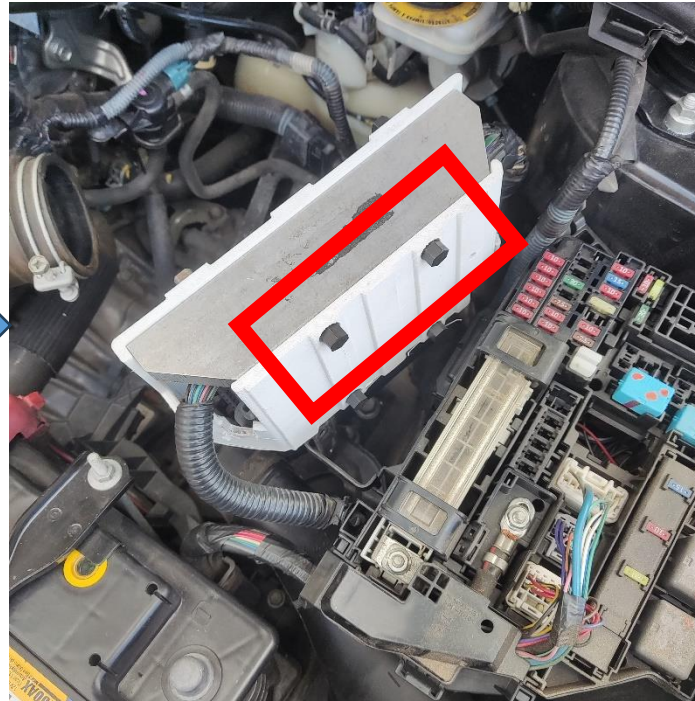

Instalação

21. Encaixe o módulo no suporte novamente e encaixe o suporte que foi removido.

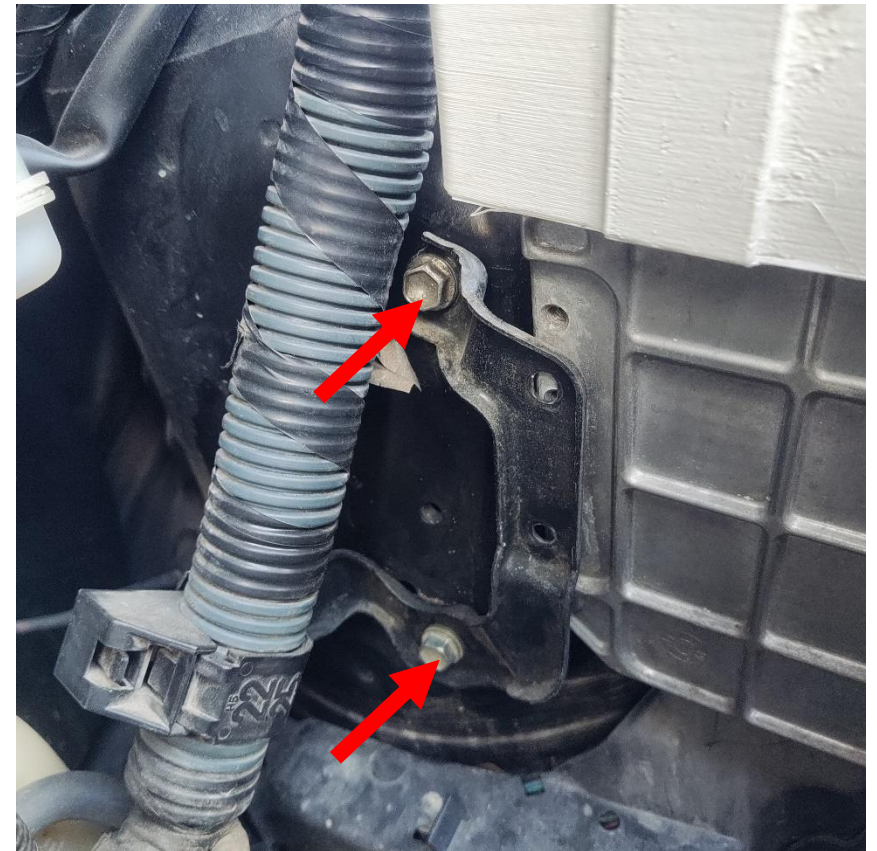
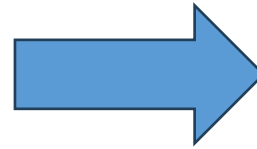

Instalação



22. Coloque os parafusos de suporte na posição indicada.

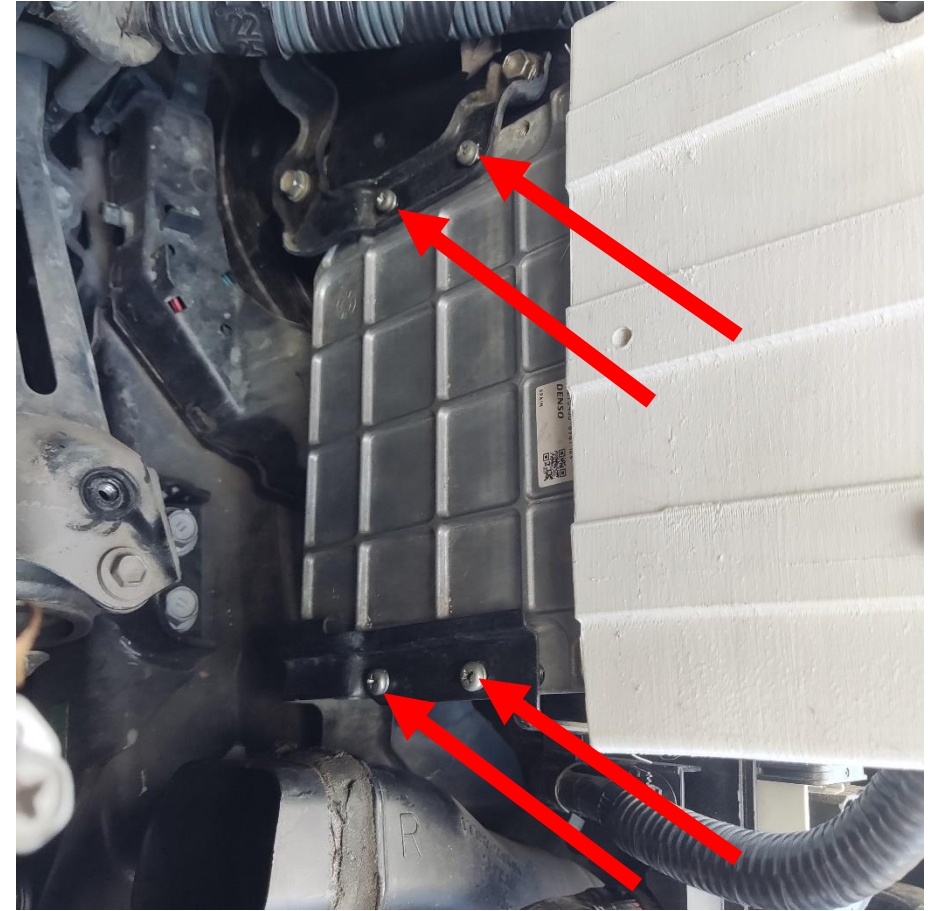
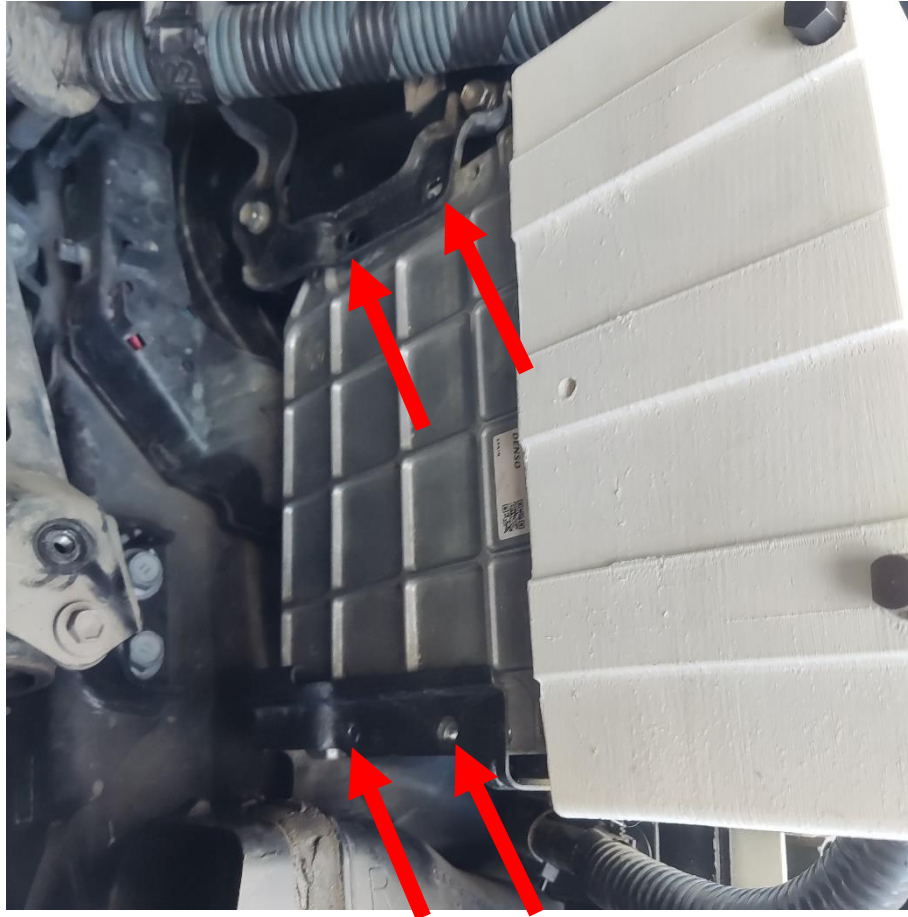

Instalação

23. Coloque a caixa do filtro de ar de volta e fixe.

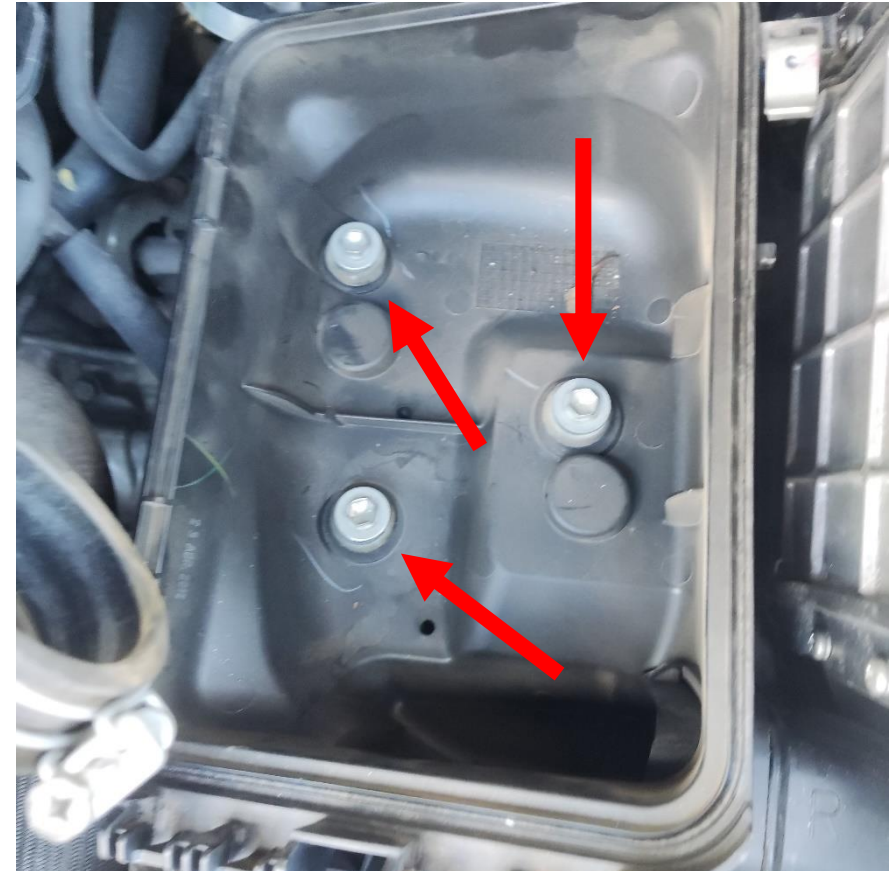
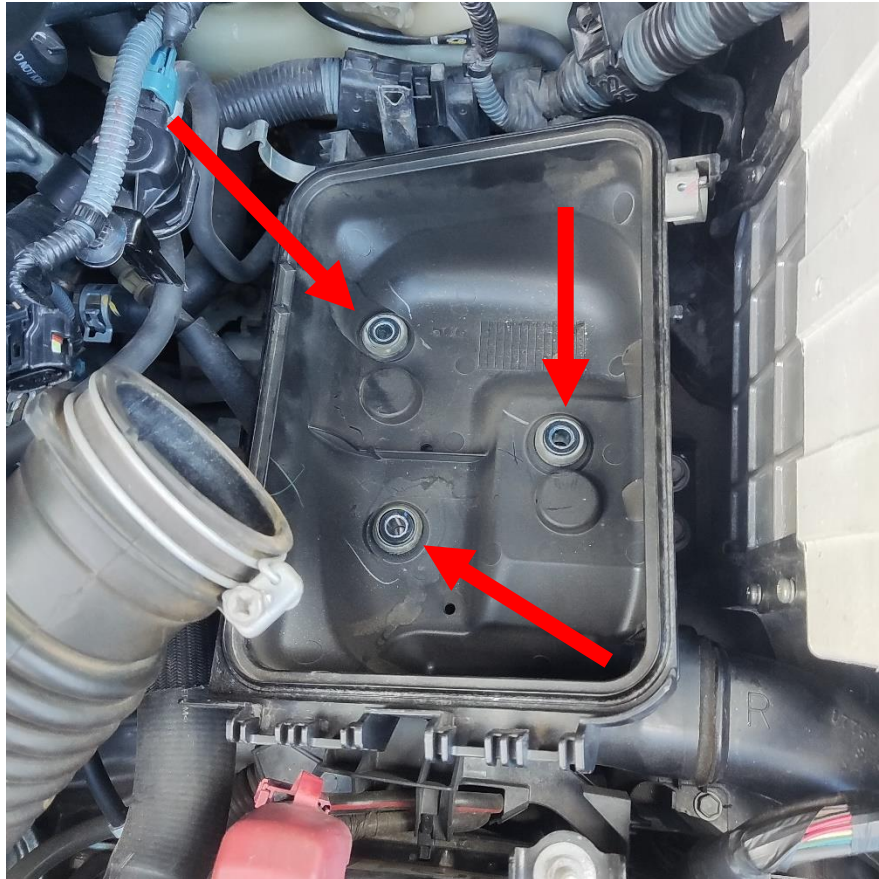

Instalação

24. Encaixe a presilha do chicote no suporte.

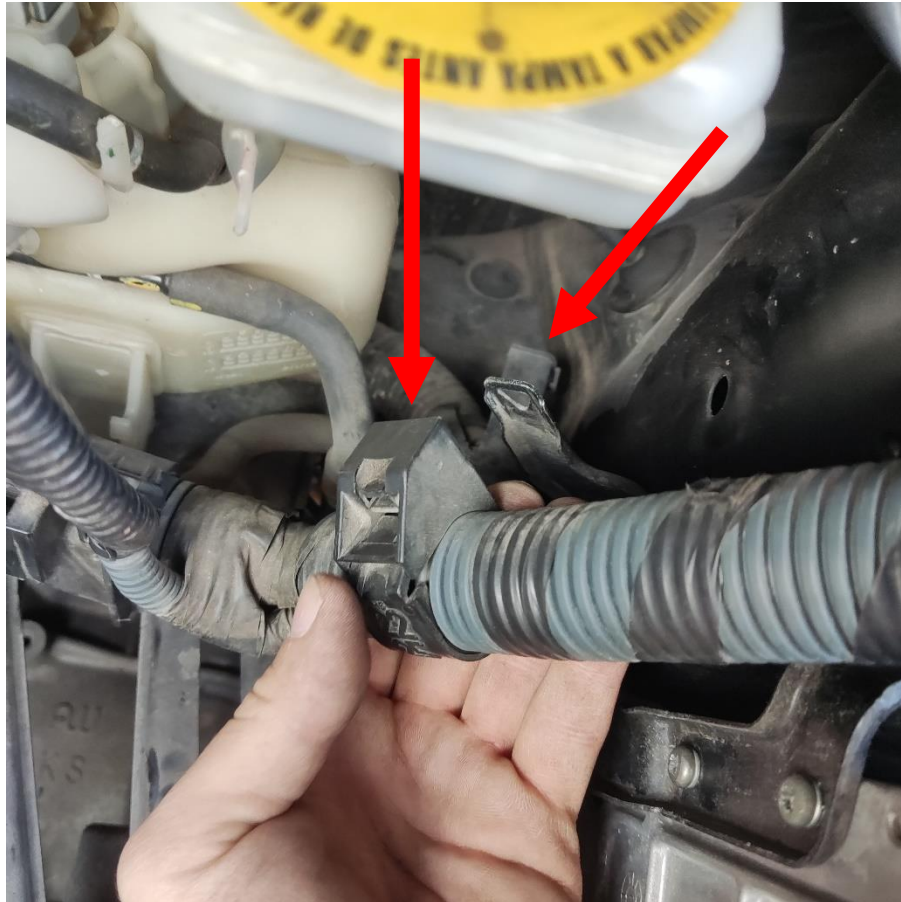

Instalação

25. Encaixe a presilha do chicote no suporte da caixa do filtro de ar.

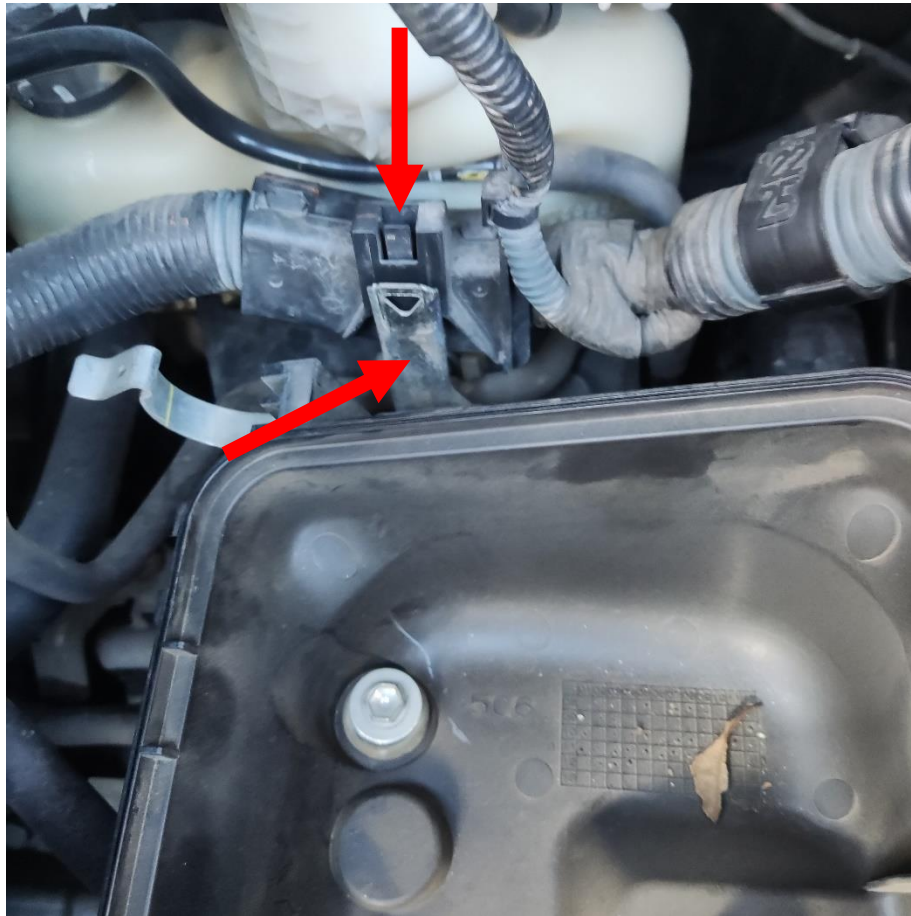

Instalação

26. Monte filtro de ar na caixa.

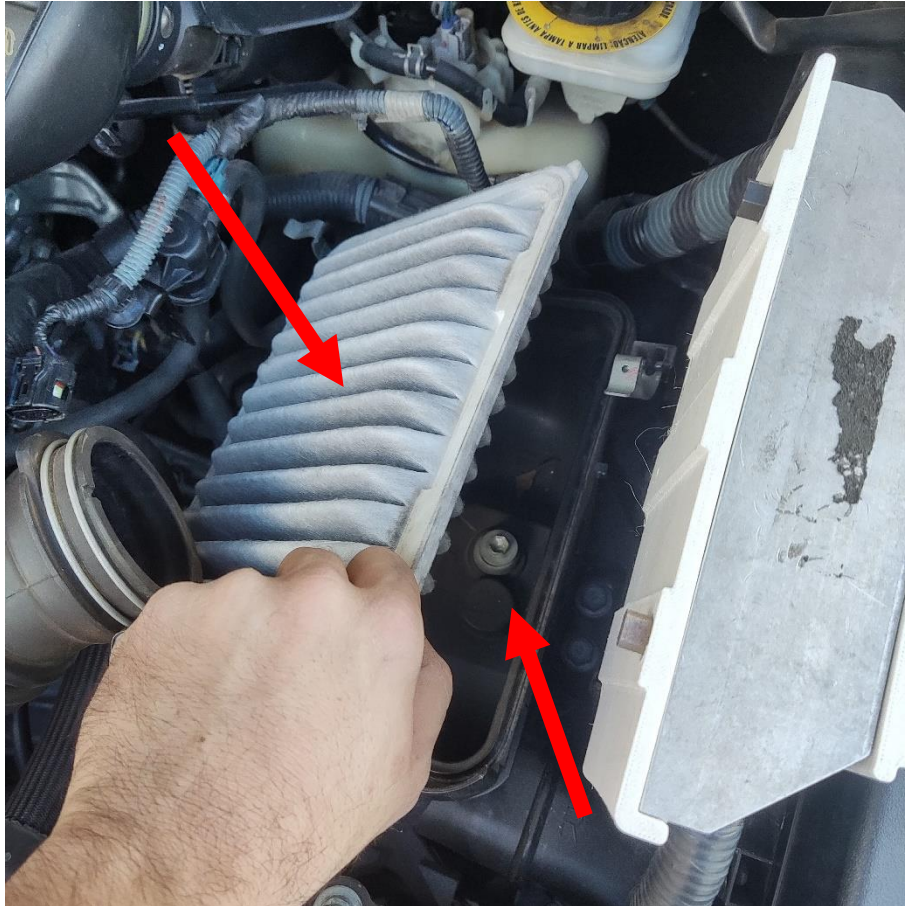

Instalação

27. Monte a tampa da caixa de ar.



Instalação

28. Trave a presilha do lado direito da caixa de admissão de ar.

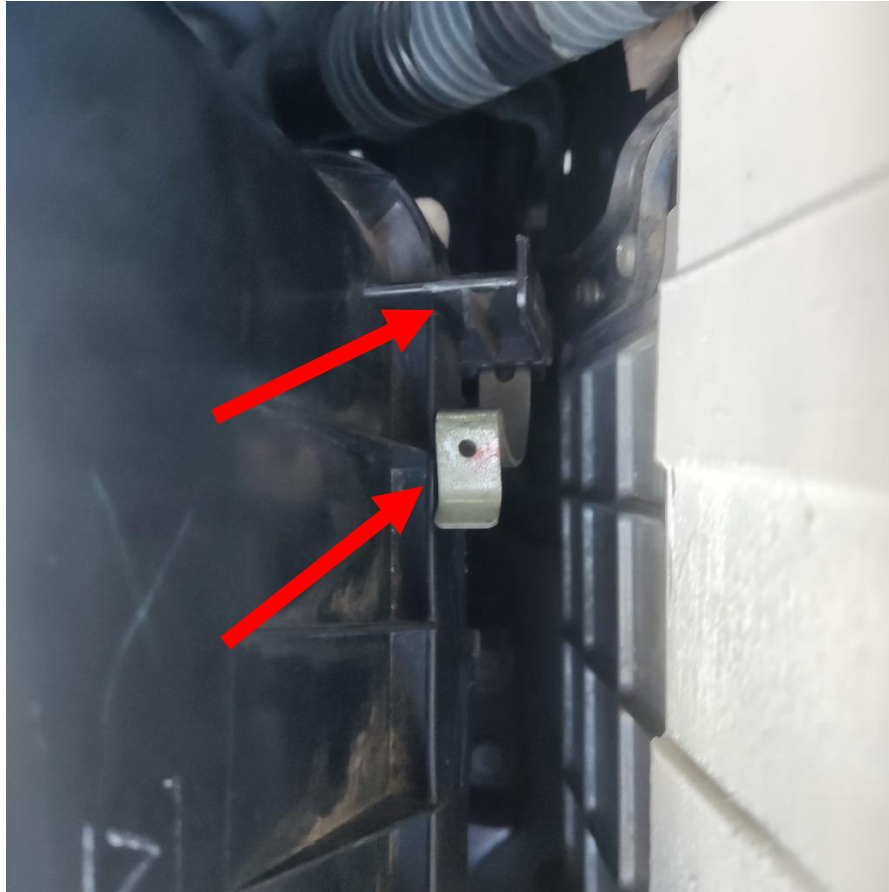

Instalação

29. Trave a presilha do lado esquerdo da caixa de admissão de ar.

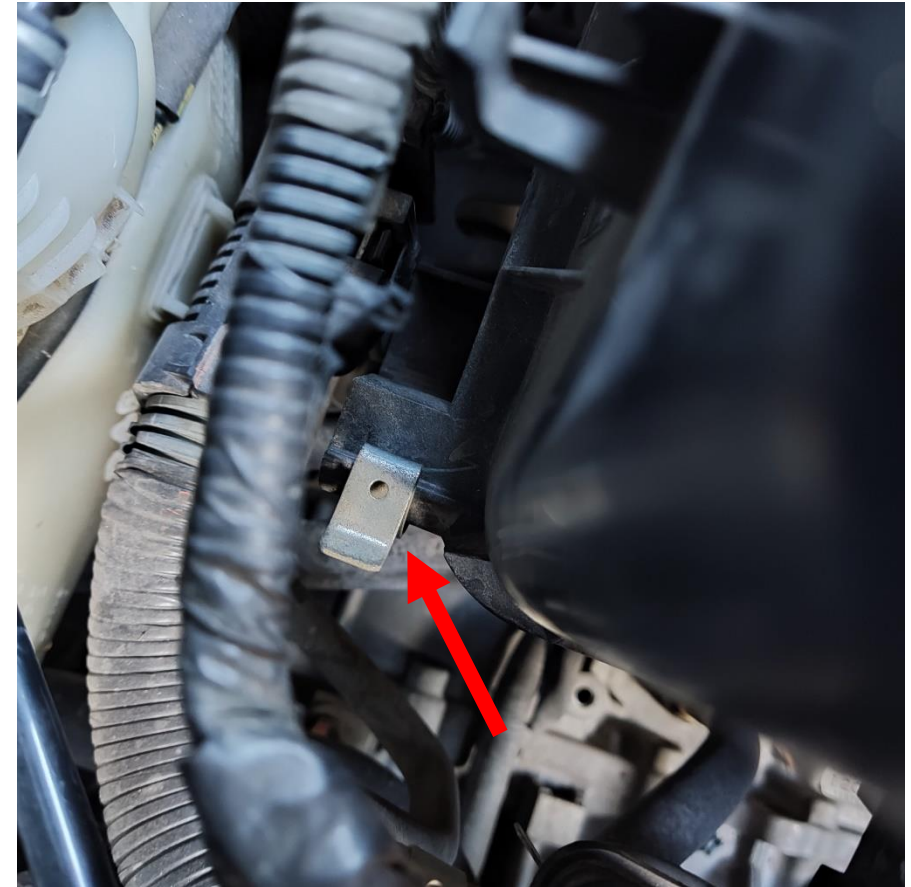
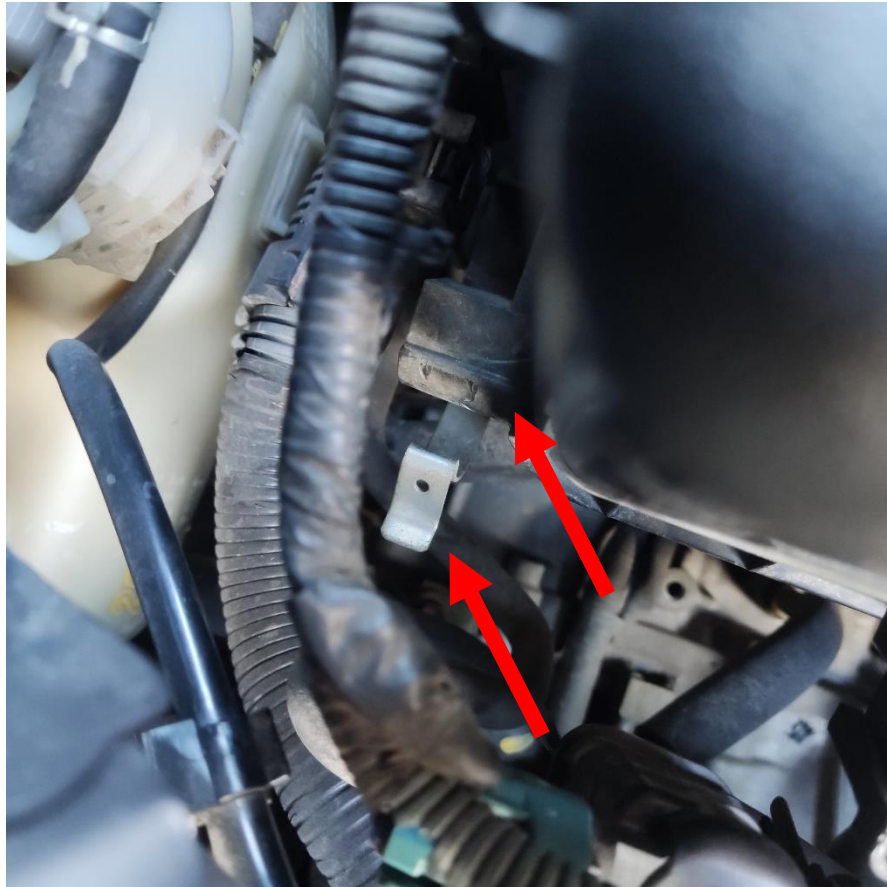

Instalação



30. Encaixe o suporte de volta na tampa da caixa do filtro de ar de cima para baixo.



Instalação

31. Reconecte o cabo do sensor na caixa de ar.

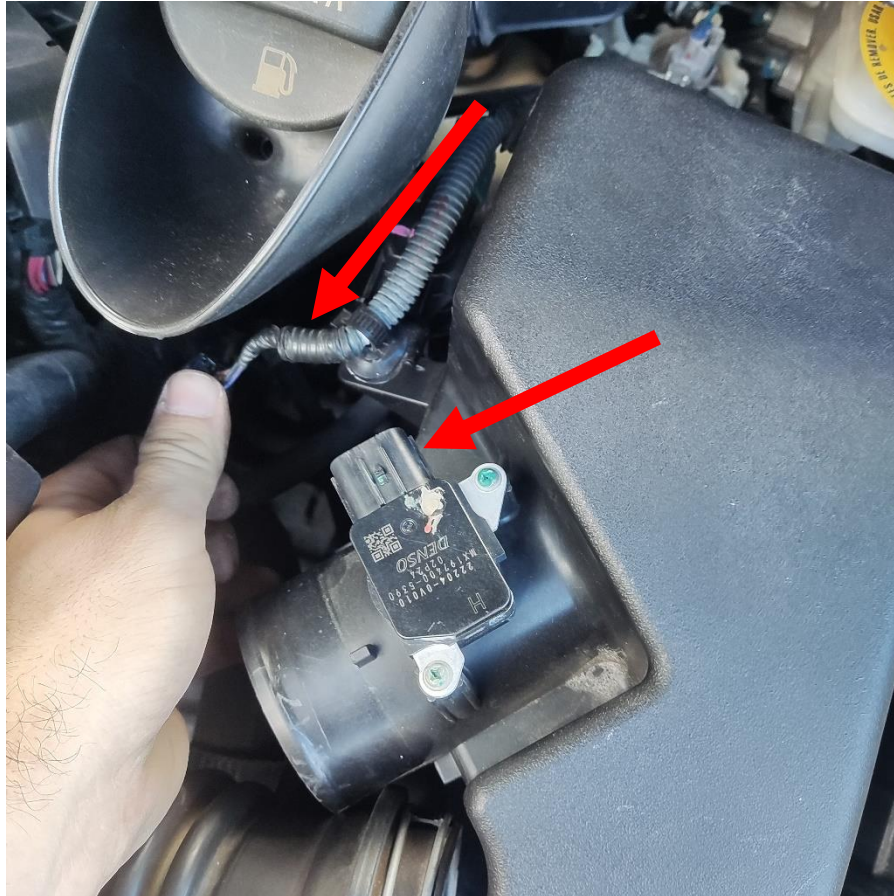

Instalação

32. Monte a mangueira de admissão na saída da caixa de ar.

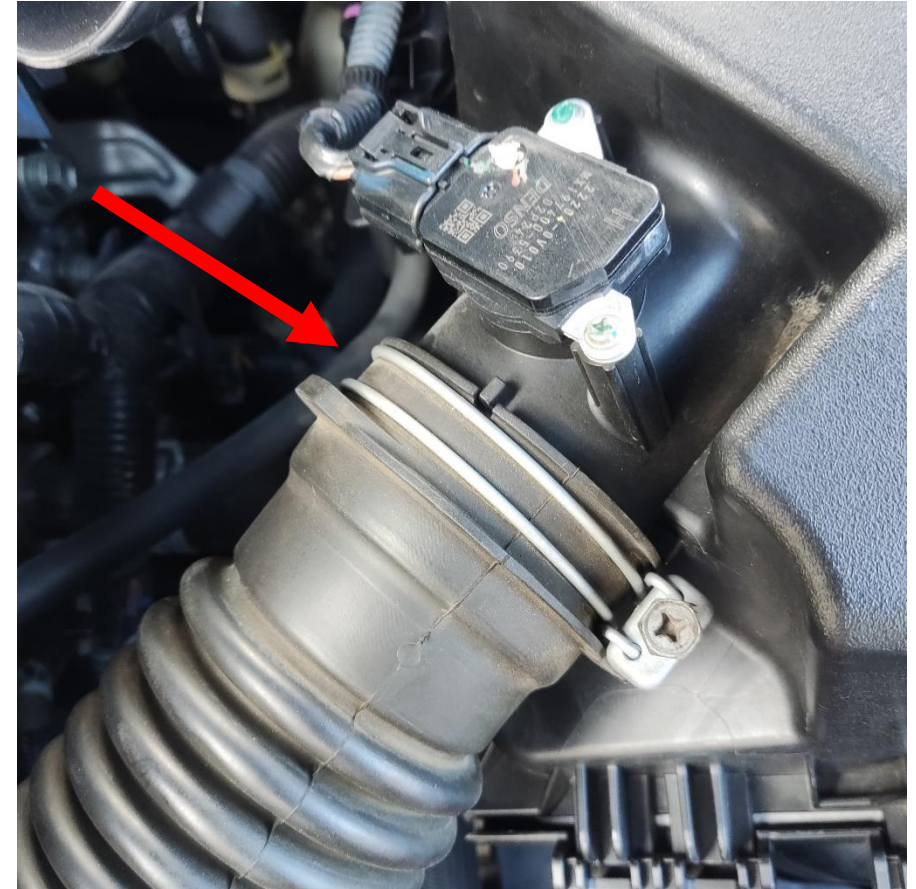
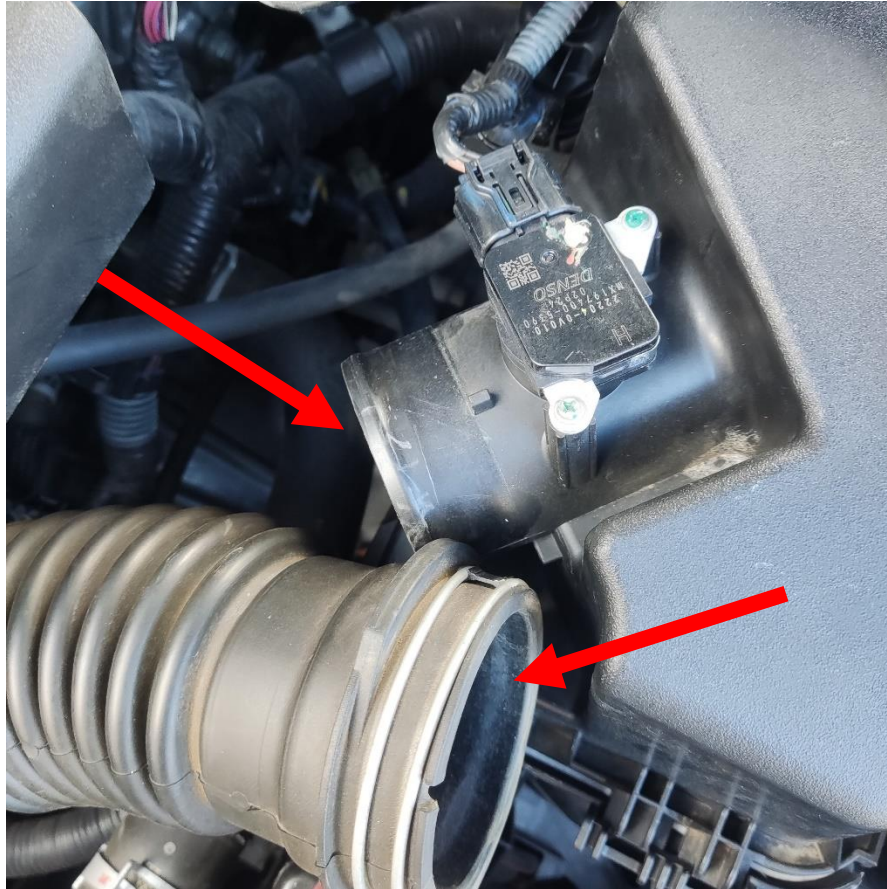

Instalação

33. Reconecte o conector negativo da bateria.

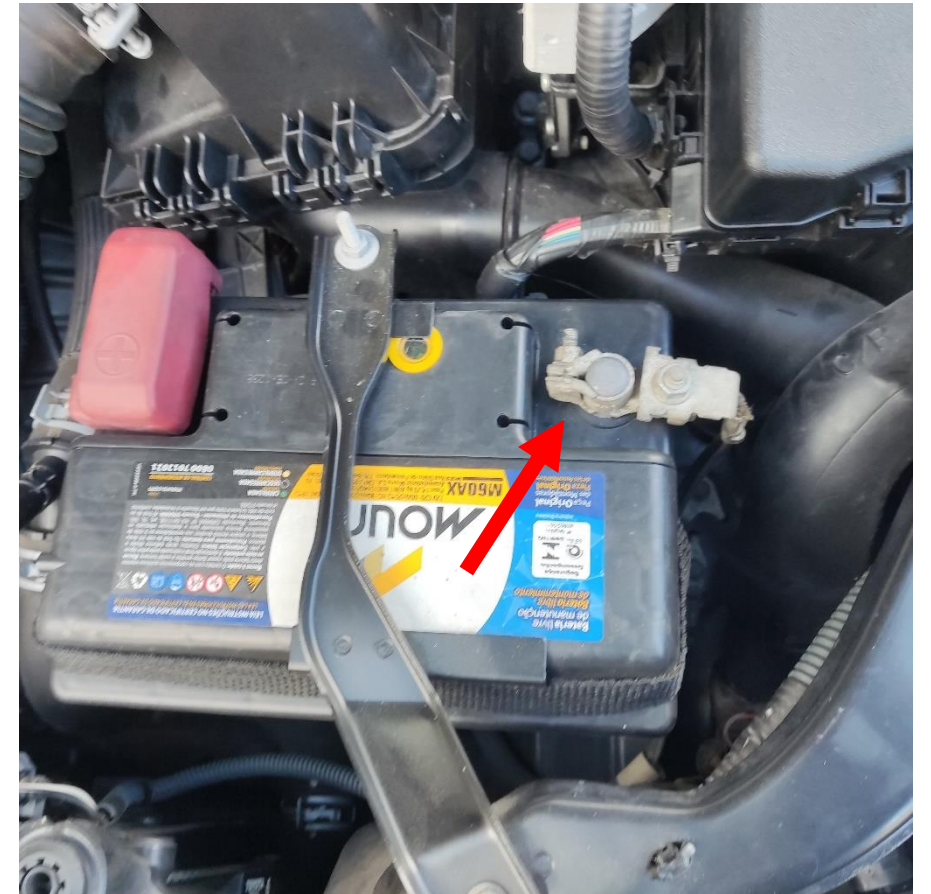
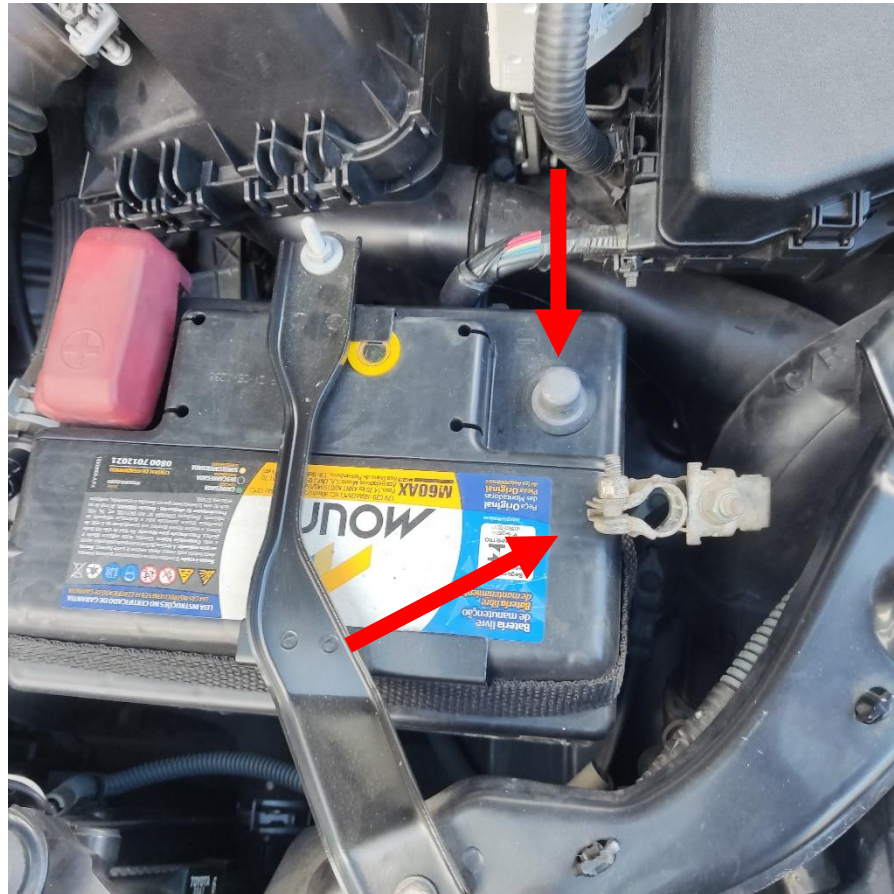

Observação



1. Antes de finalizar a instalação, ligue o veículo e veja se aparece alguma luz de defeito no painel. Caso apareça algum sinal de defeito, **PARE** agora e tente desconectar e reconectar o plugue do ECU. Quando todos os problemas forem resolvidos, pode prosseguir com a instalação do cofre quebrando os parafusos.

2. Para quebrar os parafusos:

2.1. Continuar com o aperto até o rompimento.

2.2. Tire todas as cabeças que foram quebradas dos parafusos, garanta que não fique nada no compartimento do motor, assim evitando avaria aos demais componentes.

2.3. Cuide para que não seja perdido e não tenha peças vibrando ou encostando em outras partes do veículo.

Certifique-se de remover todas as cabeças dos parafusos especiais do cofre do motor afim de evitar danos em componentes do veículo.

Instalação

34. Coloque de volta a tampa da caixa de fusível.

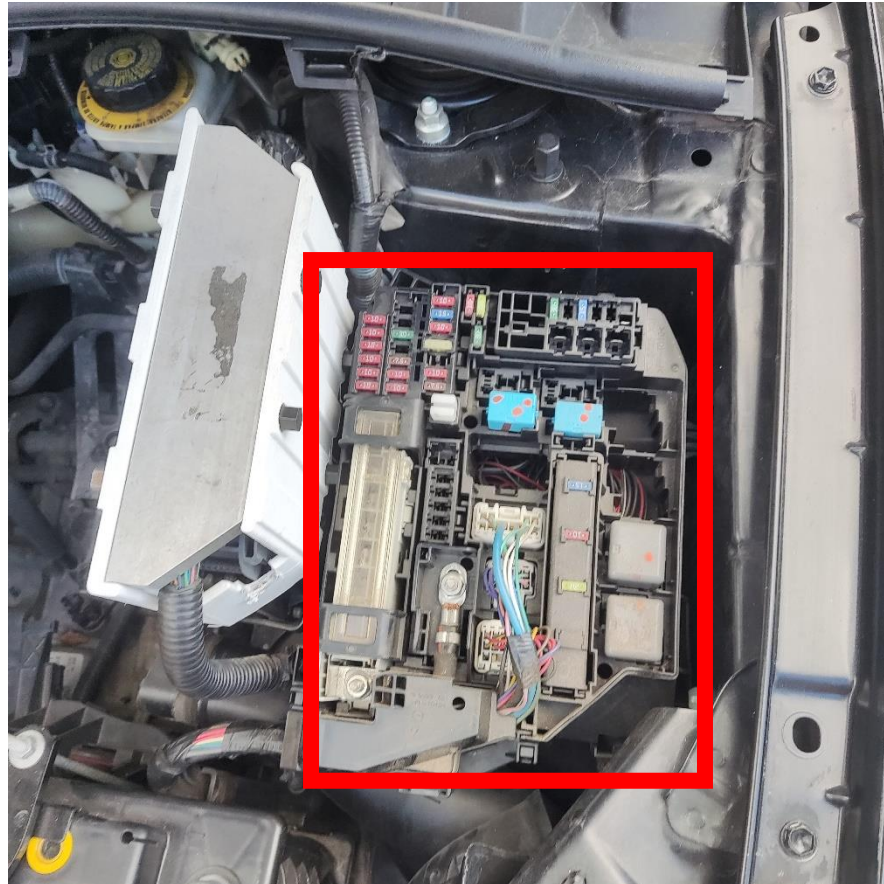

Instalação

35. Coloque o encaixe no locais indicados.

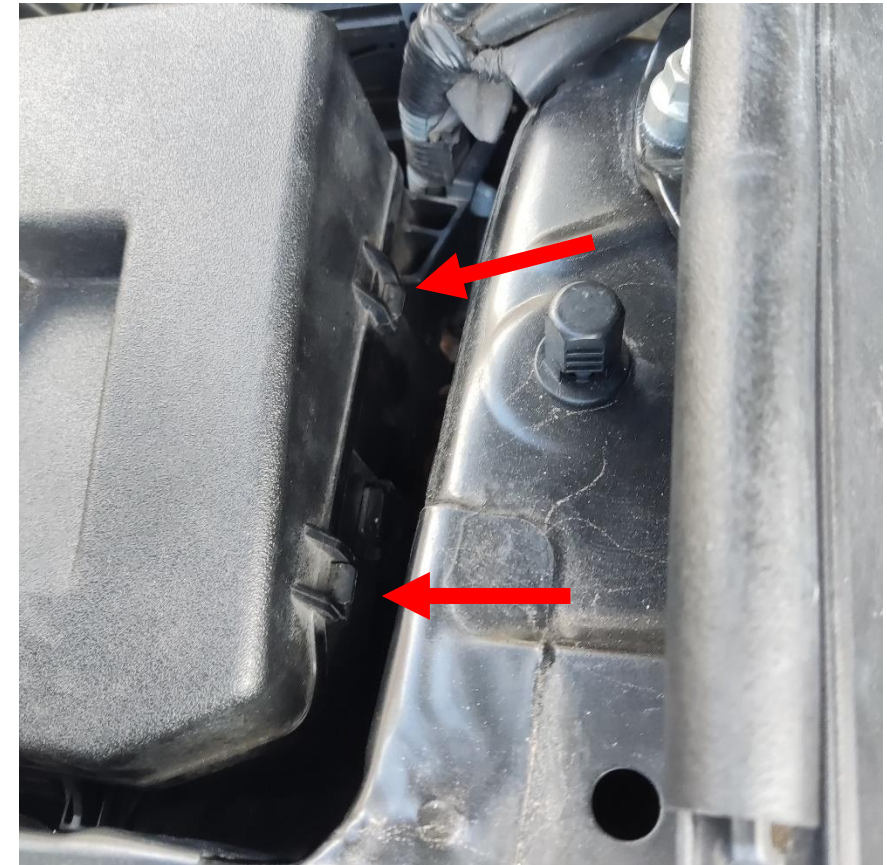

Atenção



- Esse produto, bem como seu manual de instalação, foram desenvolvidos por profissionais técnicos;
- A SAFECAR não se responsabiliza por nenhum dano, seja físico ou financeiro, causado pelo uso incorreto do produto ou das instruções;
- Em caso de dúvida ou comentário, entre em contato conosco: tecnico@safecar.net.br



SAFECAR

ESPECIALISTA CONTRA CRIMES AUTOMOTIVOS

Safecar Brasil Importação, Exportação e Participações Ltda.
Rua Eliseu de Oliveira, 40 – Cidade Monções – São Paulo – SP
Tel. (11) 5505-1548
www.safecar.biz