

Guia de instalação SAFECAR – Cofre Blindado BR264



SAFECAR

ESPECIALISTA CONTRA CRIMES AUTOMOTIVOS

Atenção



- A instalação deve ser feita somente por profissionais autorizados;
- Ligar o carro para garantir que não exista nenhuma luz indicando defeito no painel;
- Caso tenha alguma luz de defeito acesa, informe o cliente antes do início da instalação;
- Aguarde 15 minutos após o desligamento do veículo para iniciar o processo de instalação;
- Não desmonte qualquer peça do veículo que não apareça neste guia;
- Ao final da instalação devolva as chaves do veículo onde as pegou.

Componentes do Cofre Blindado

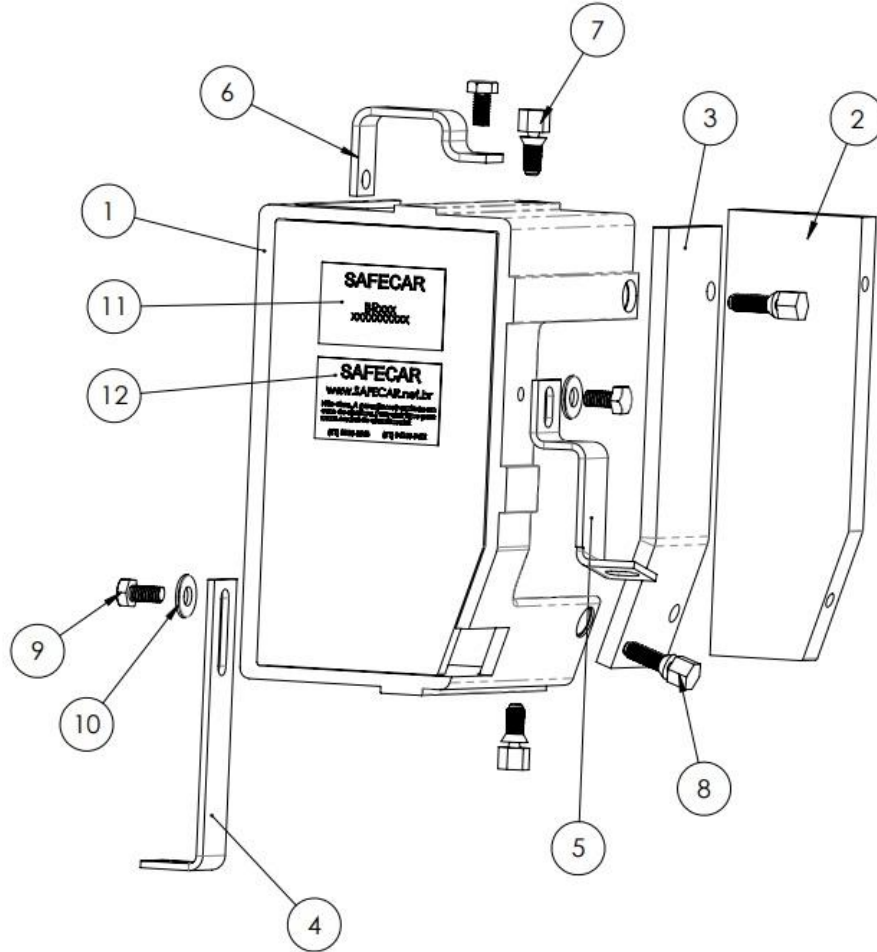

Item	Peça	Quantidade
1	Caixa do cofre	1
2	Tampa	1
3	Tampa complementar	1
4	Suporte	1
5	Suporte	1
6	Suporte	1
7	Parafuso especial	2
8	Parafuso especial longo	2
9	Parafuso M6x12	4
10	Arruela 1/4"	2
11	Etiqueta Produto	1
12	Etiqueta Safecar	1

Instalação

1. Retire o conector do polo negativo (-) da bateria.

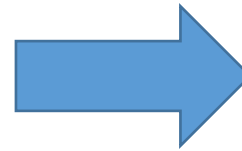
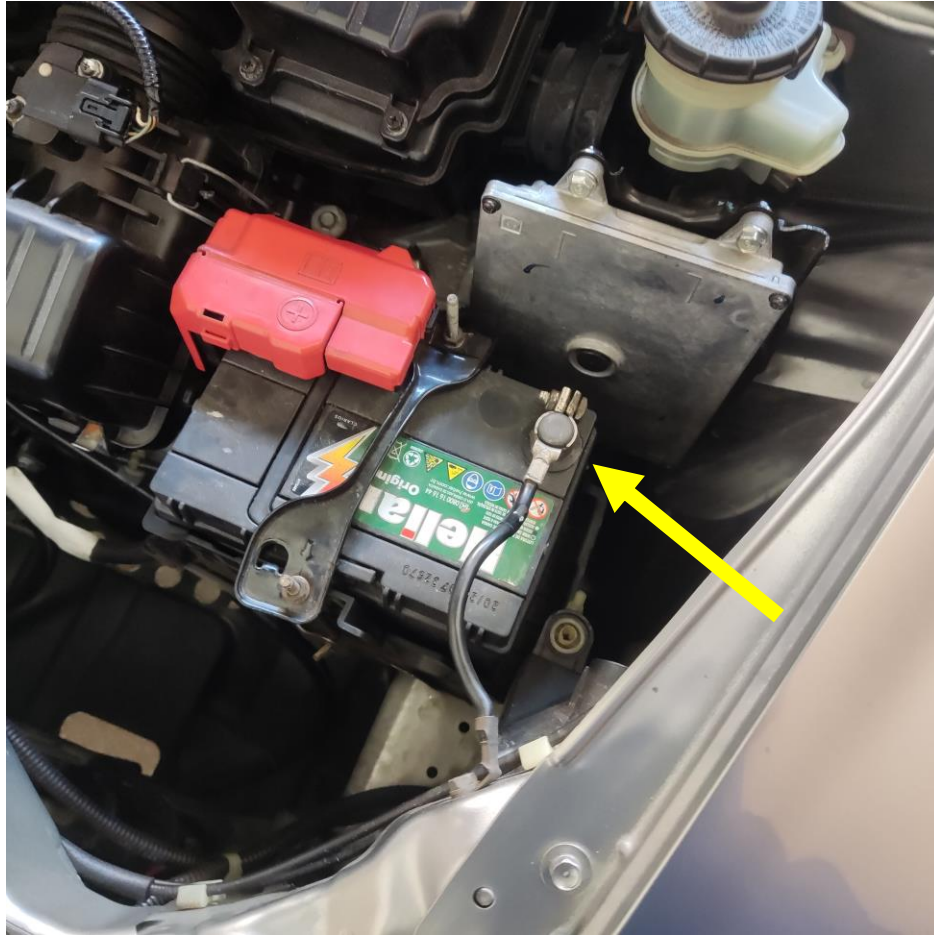

Instalação

2. Solte o conector do sensor.

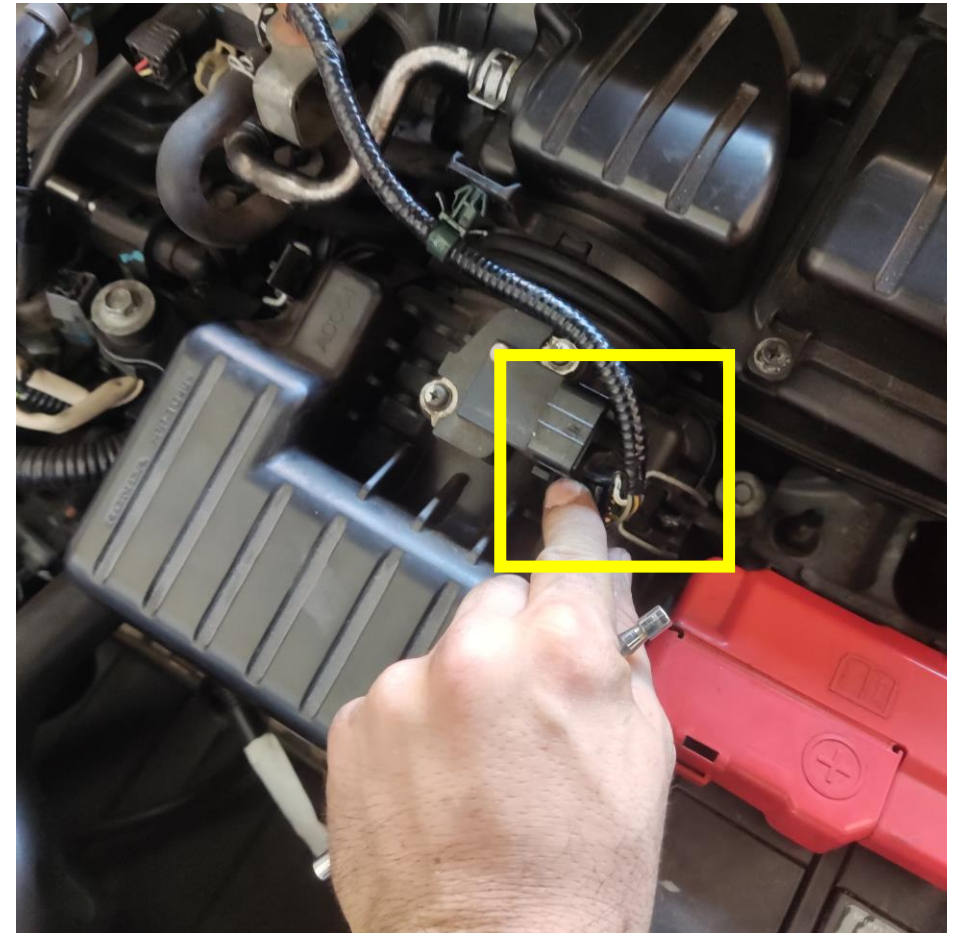
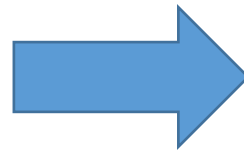
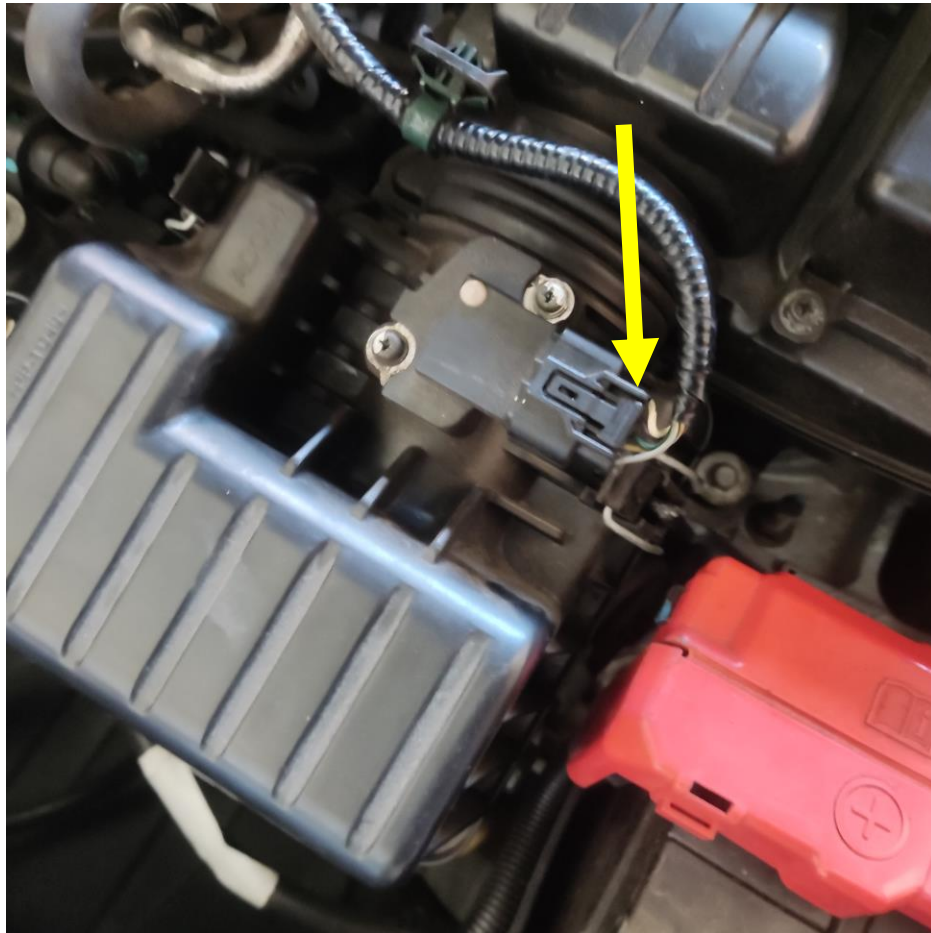

Instalação

3. Solte a presilha do chicote e enrole para facilitar a instalação.

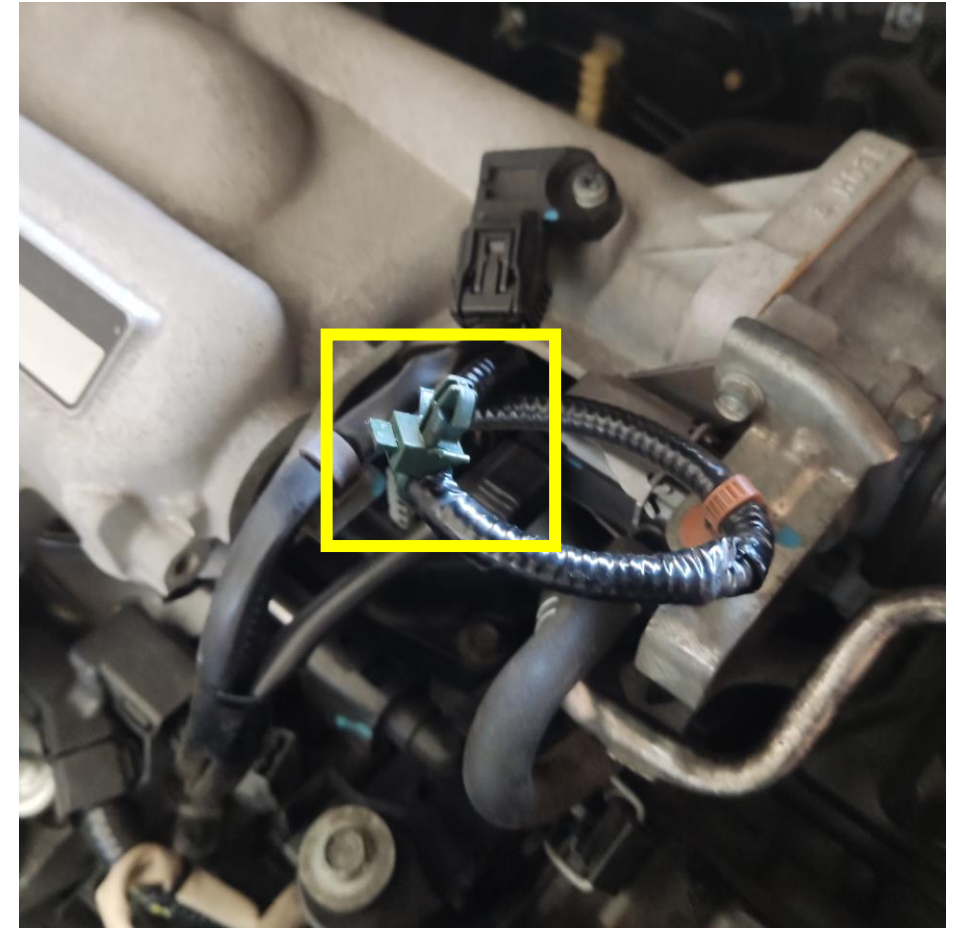
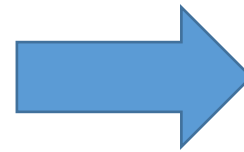
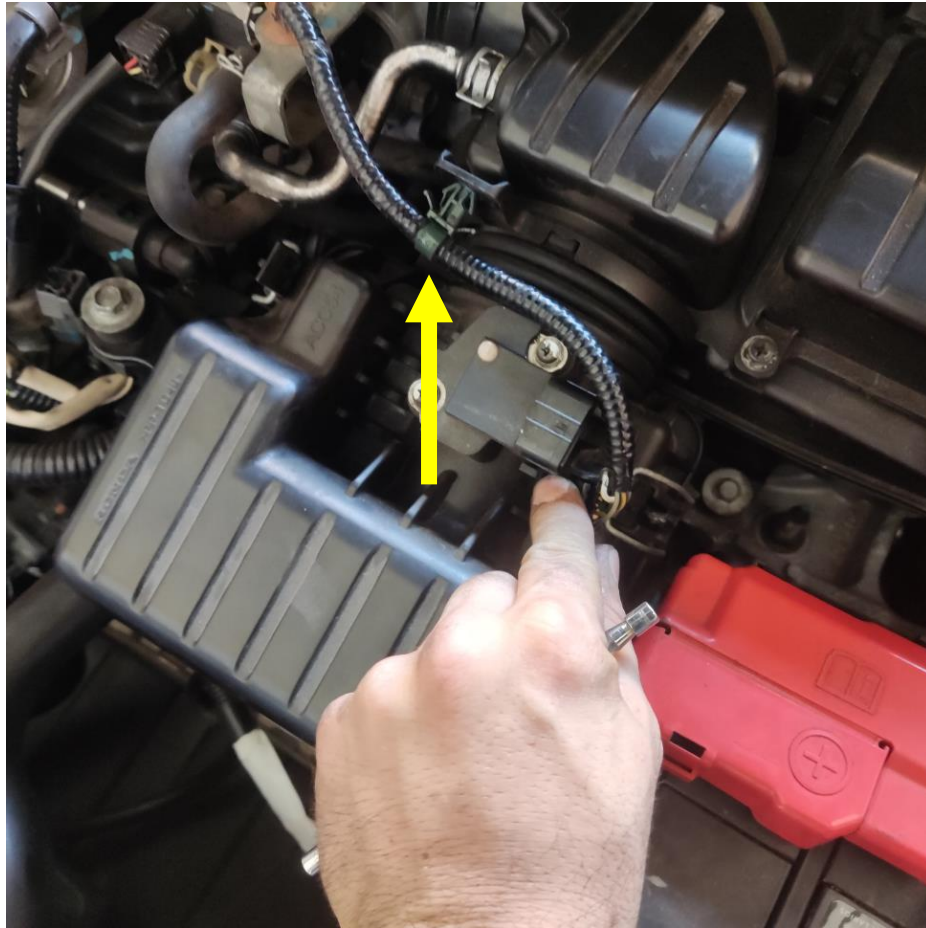

Instalação

4. Solte o parafuso indicado.

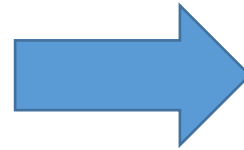
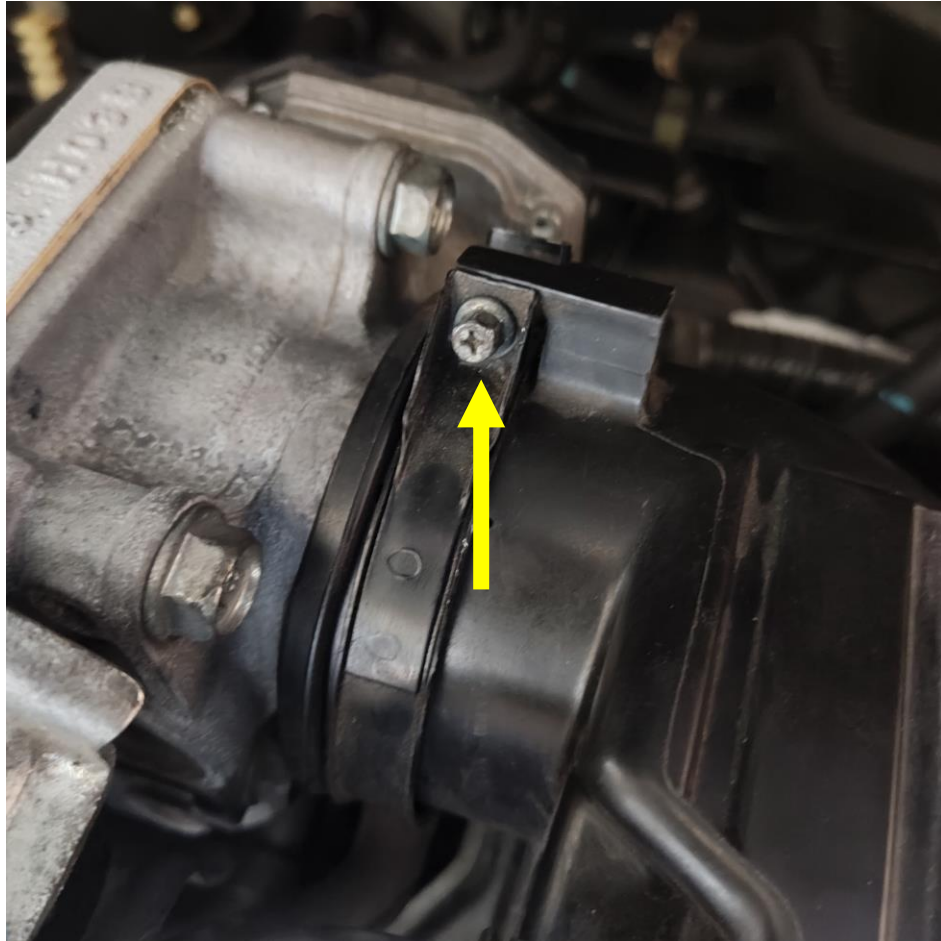

Instalação

5. Pressione as orelhas da presilha uma contra a outra para soltar ela.

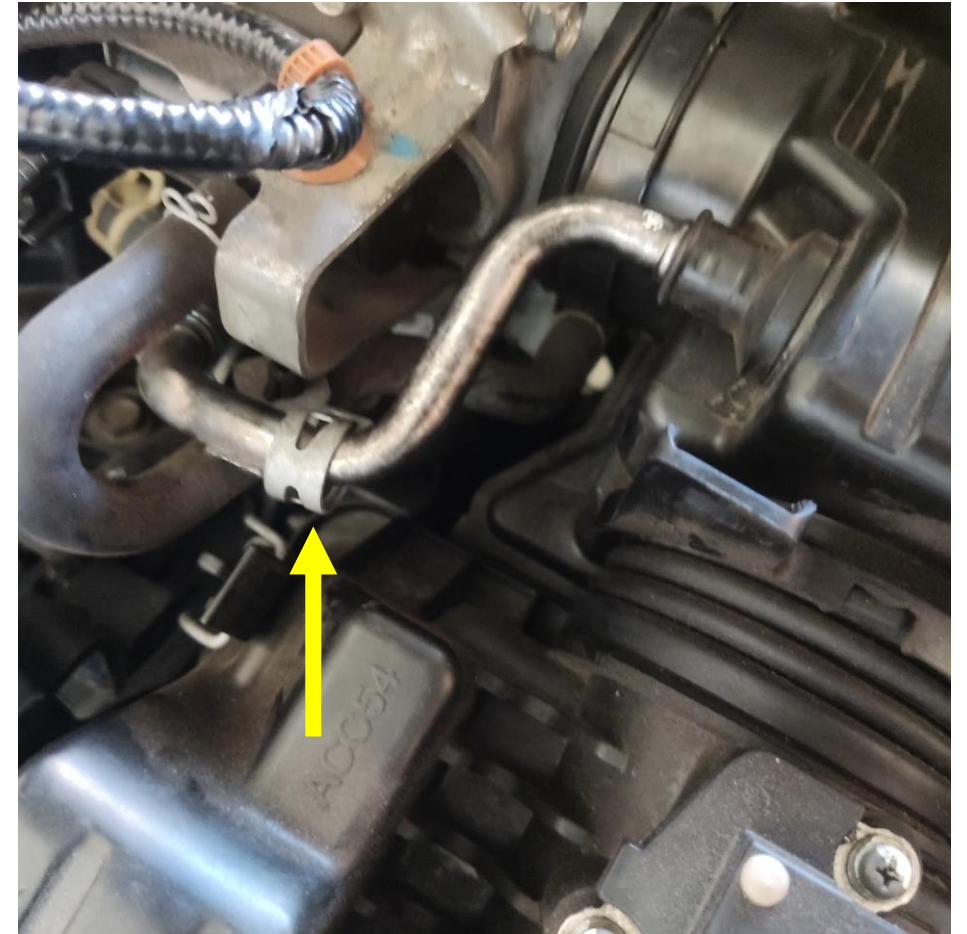
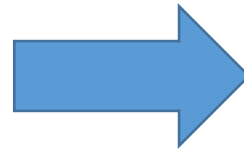
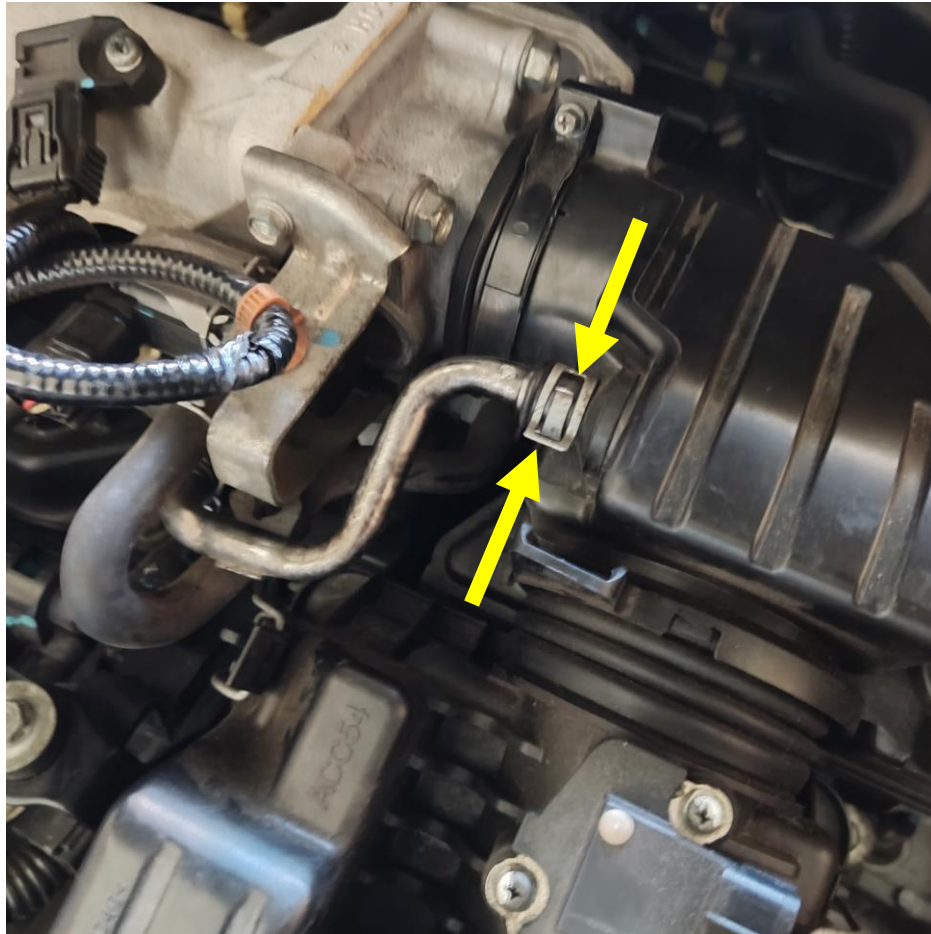

Instalação

6. Retire o parafuso indicado.

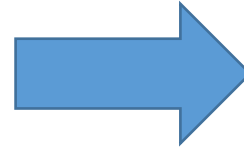
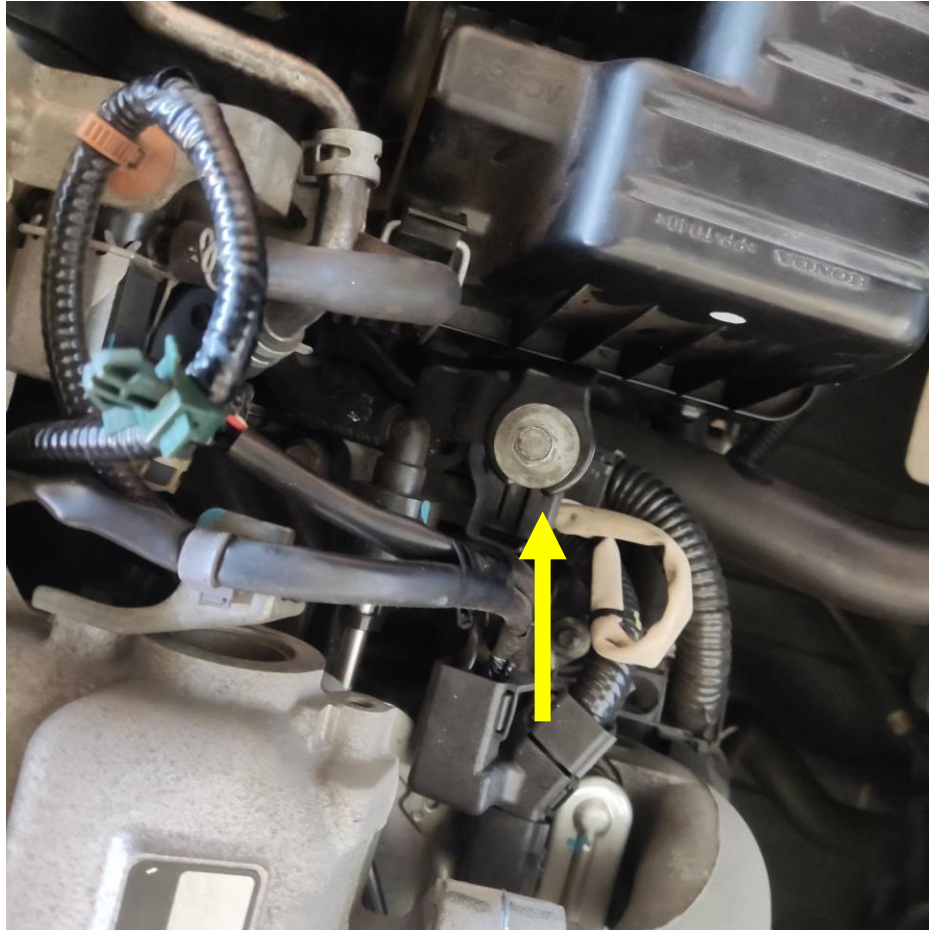

Instalação

7. Retire o parafuso indicado.

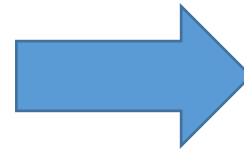
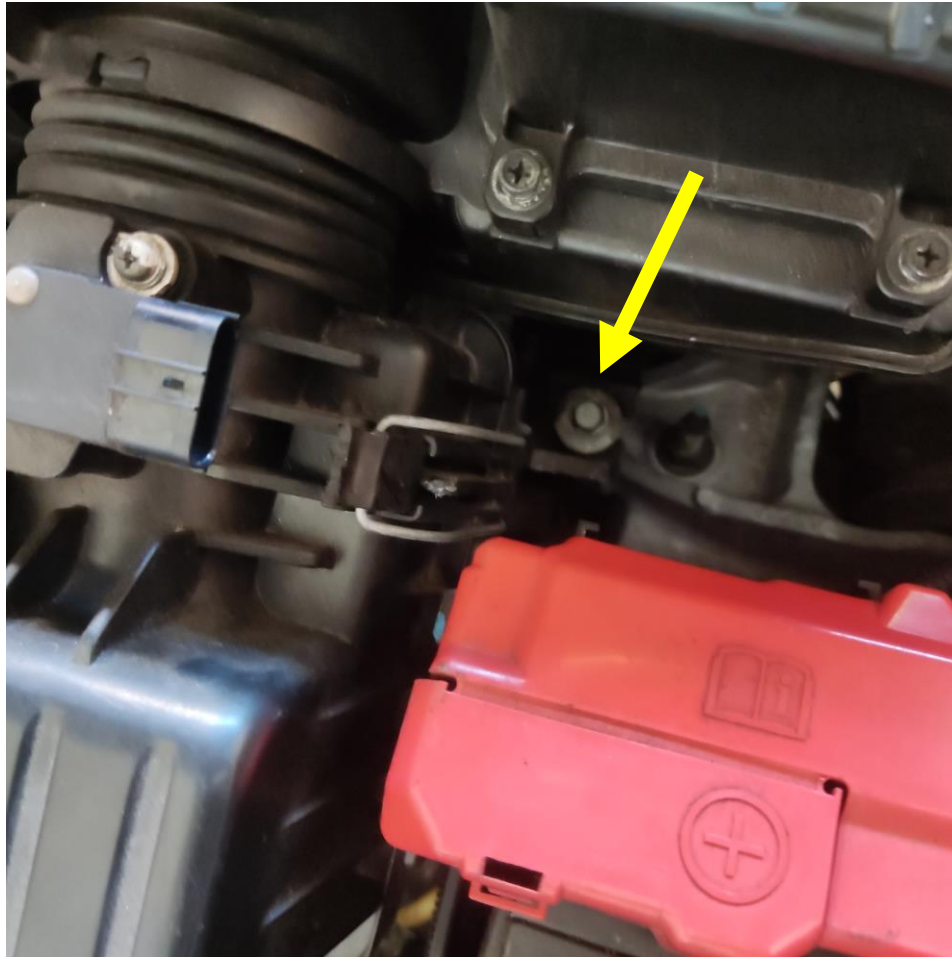

Instalação

8. Retire a caixa filtro de ar.

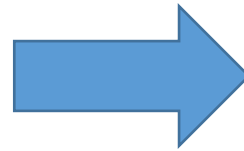

Instalação

9. Puxe a capa e retire o conector do polo positivo (+) da bateria.

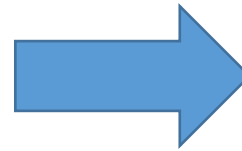

Instalação

10. Retire a trava da bateria.

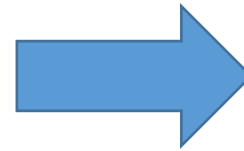

Instalação

11. Retire a bateria do suporte.



Instalação

12. Retire o suporte de bateria.

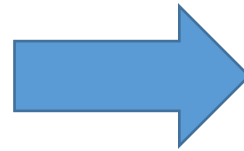
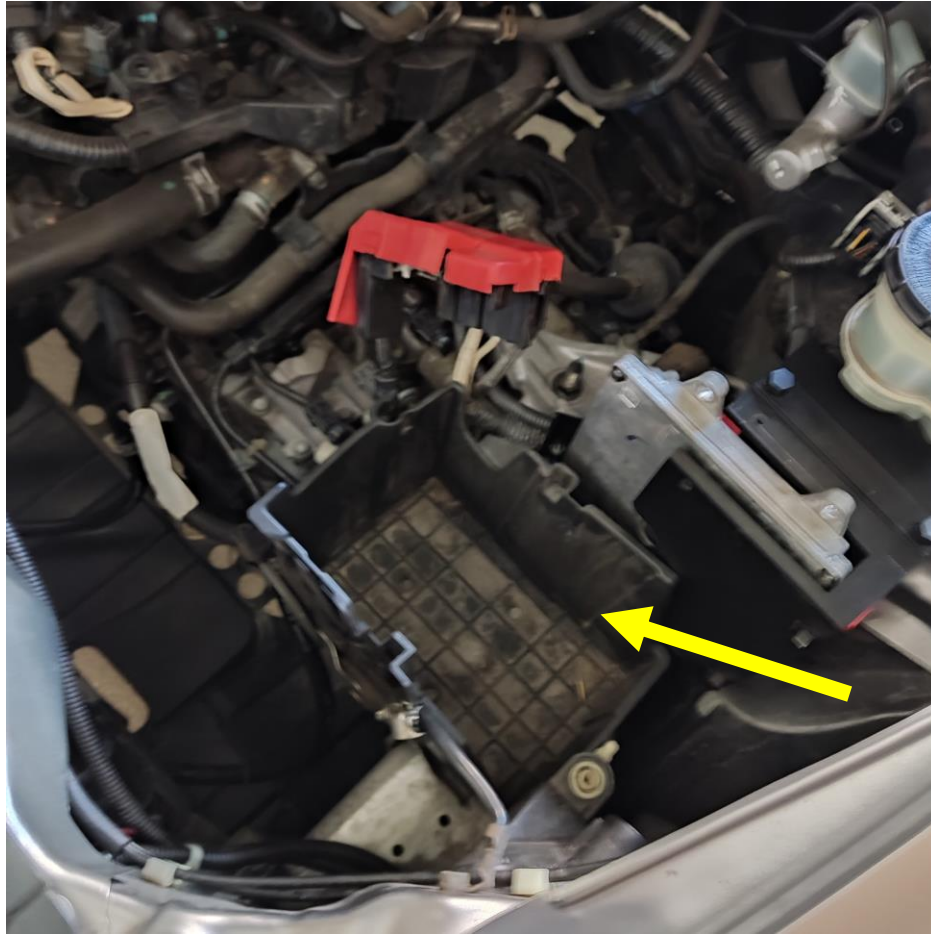

Instalação

13. Retire o conector do sensor do reservatório do fluido de freio.

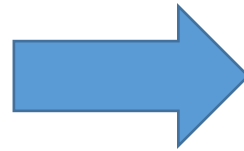
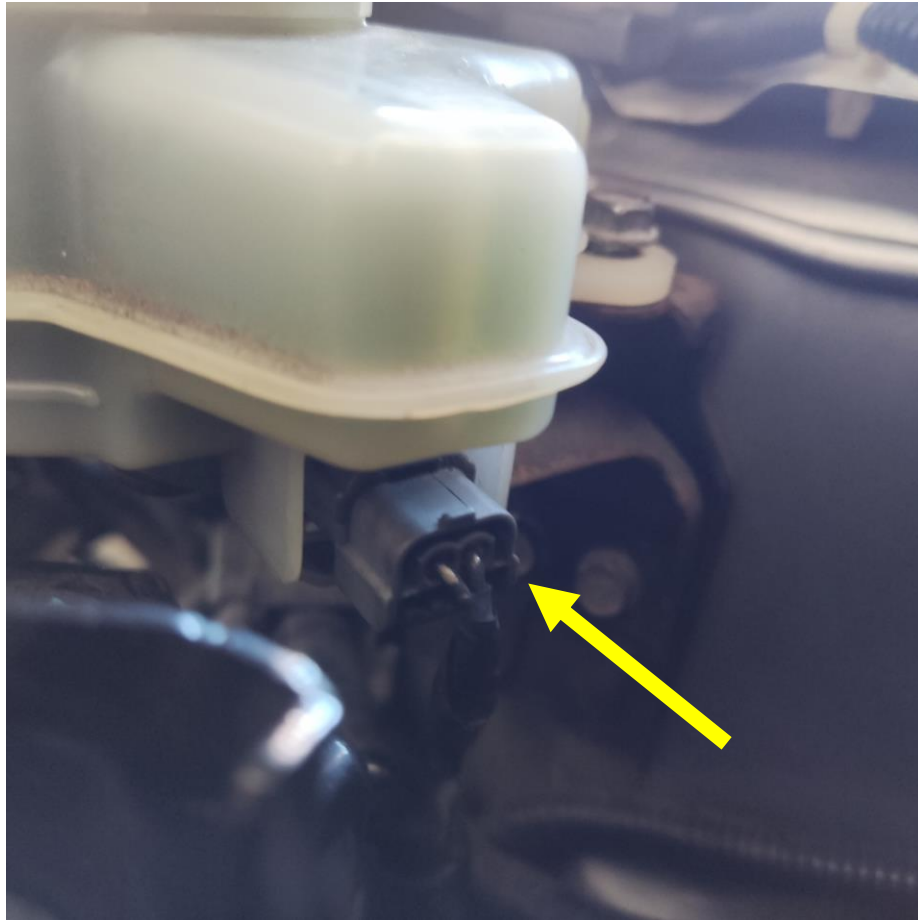

Instalação

14. Retire o parafuso indicado.

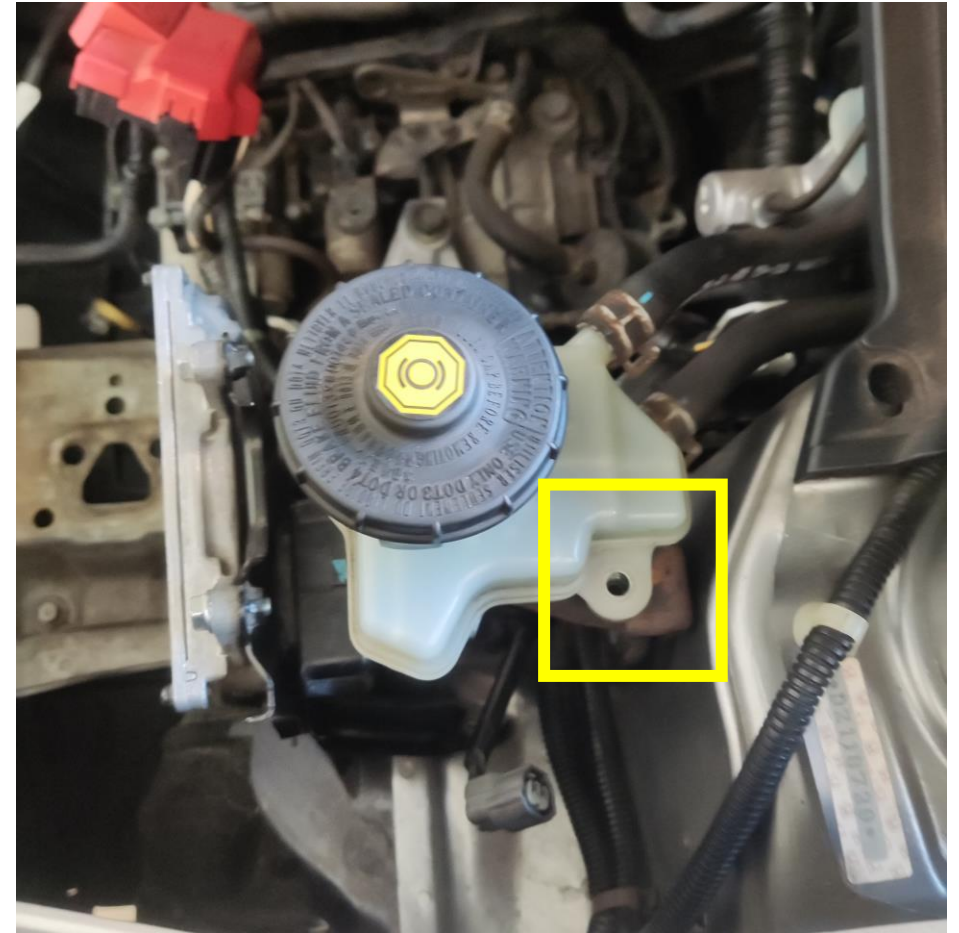
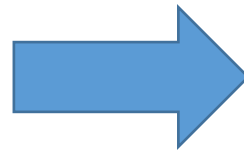

Instalação

15. Remova o reservatório d'água.

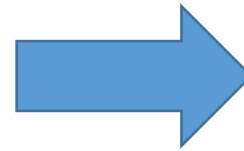

Instalação

16. Retire o parafuso indicado.

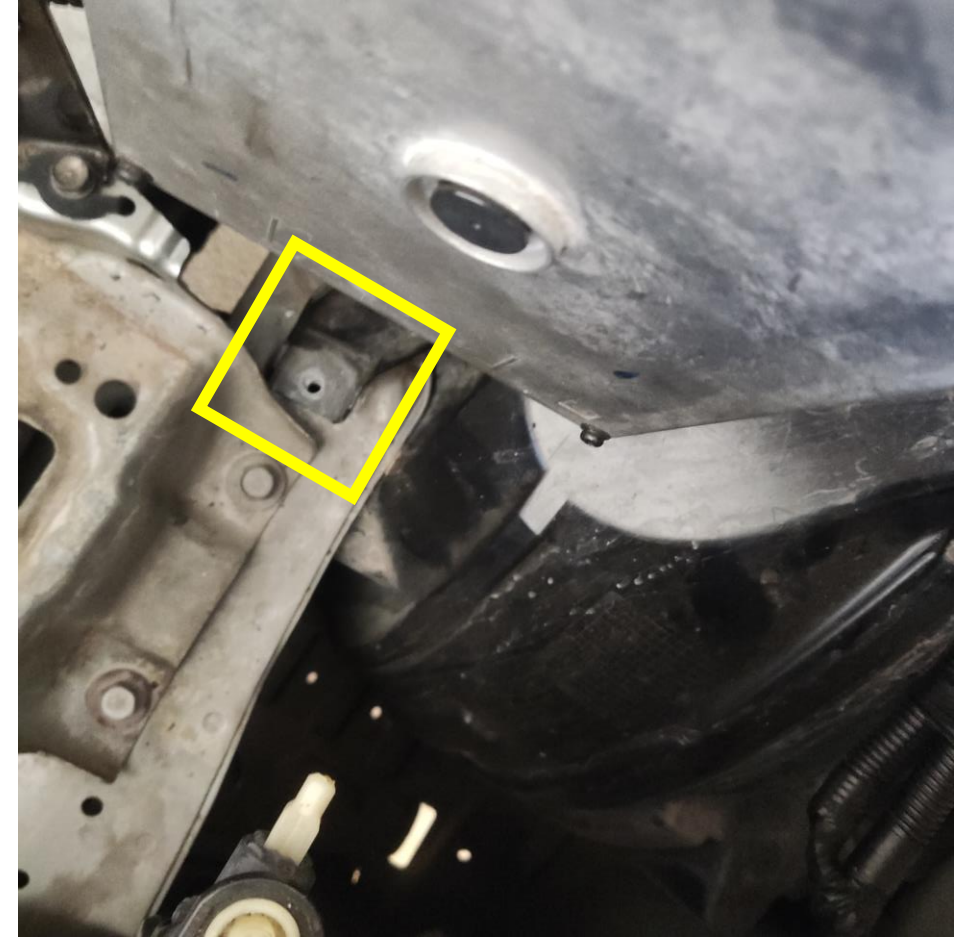
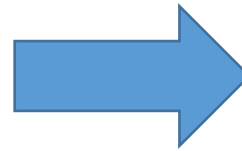
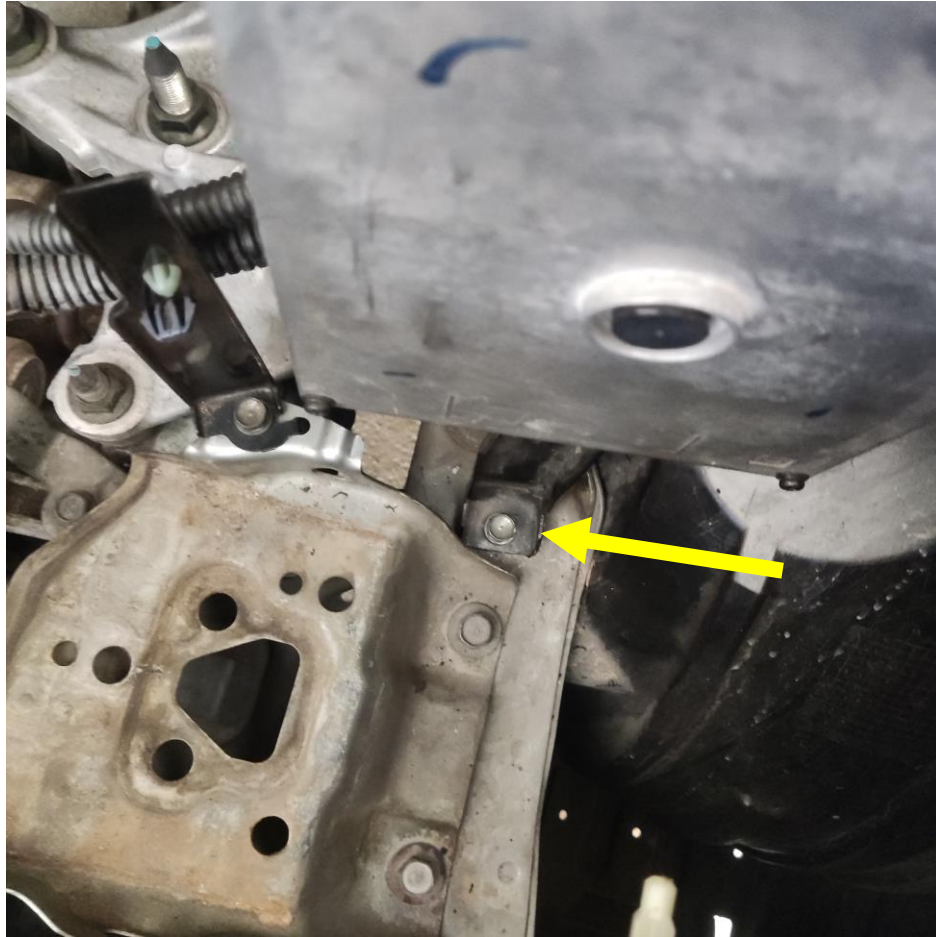

Instalação

17. Retire o parafuso indicado.

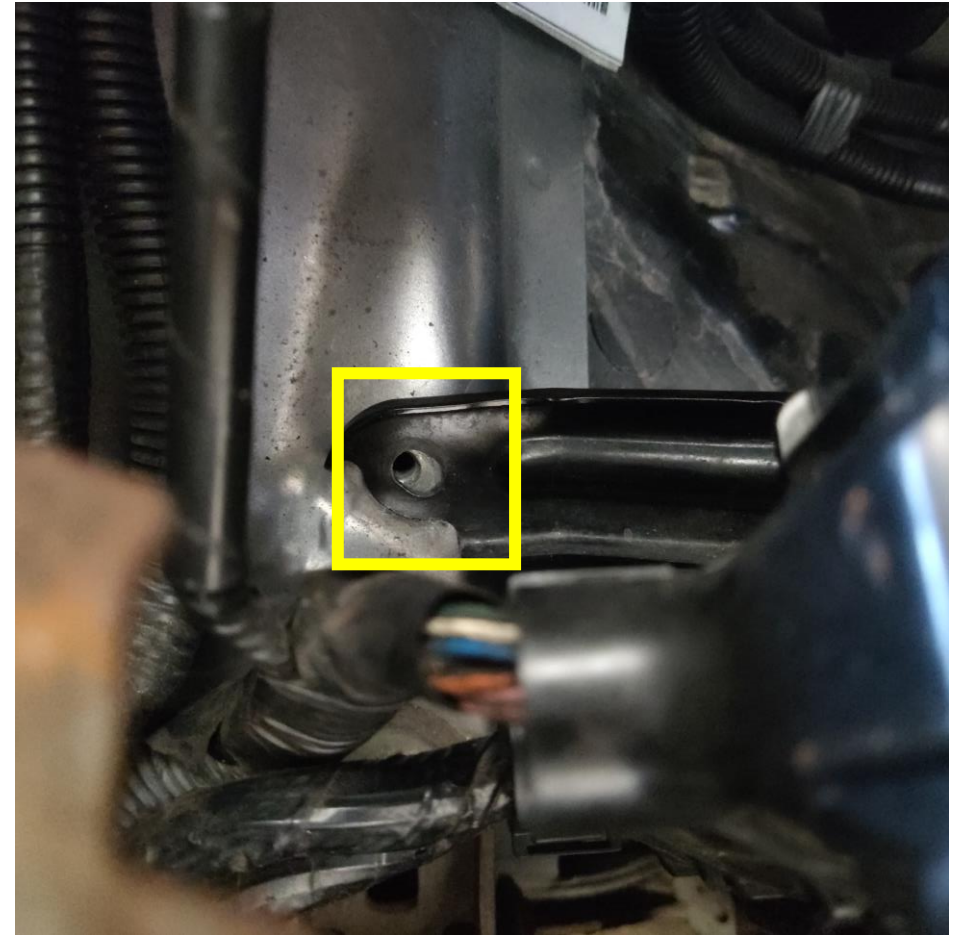
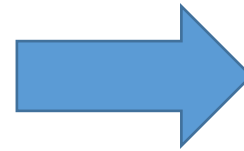
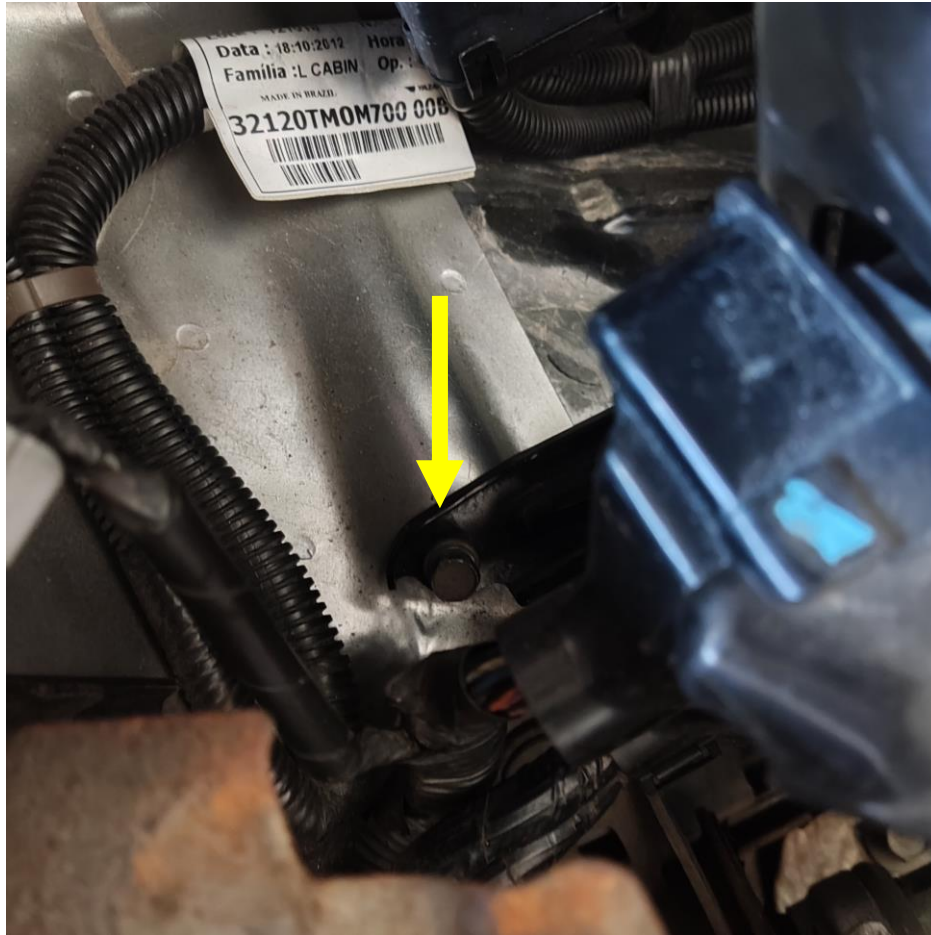

Instalação

18. Retire os parafusos indicados.

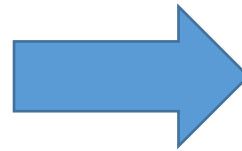
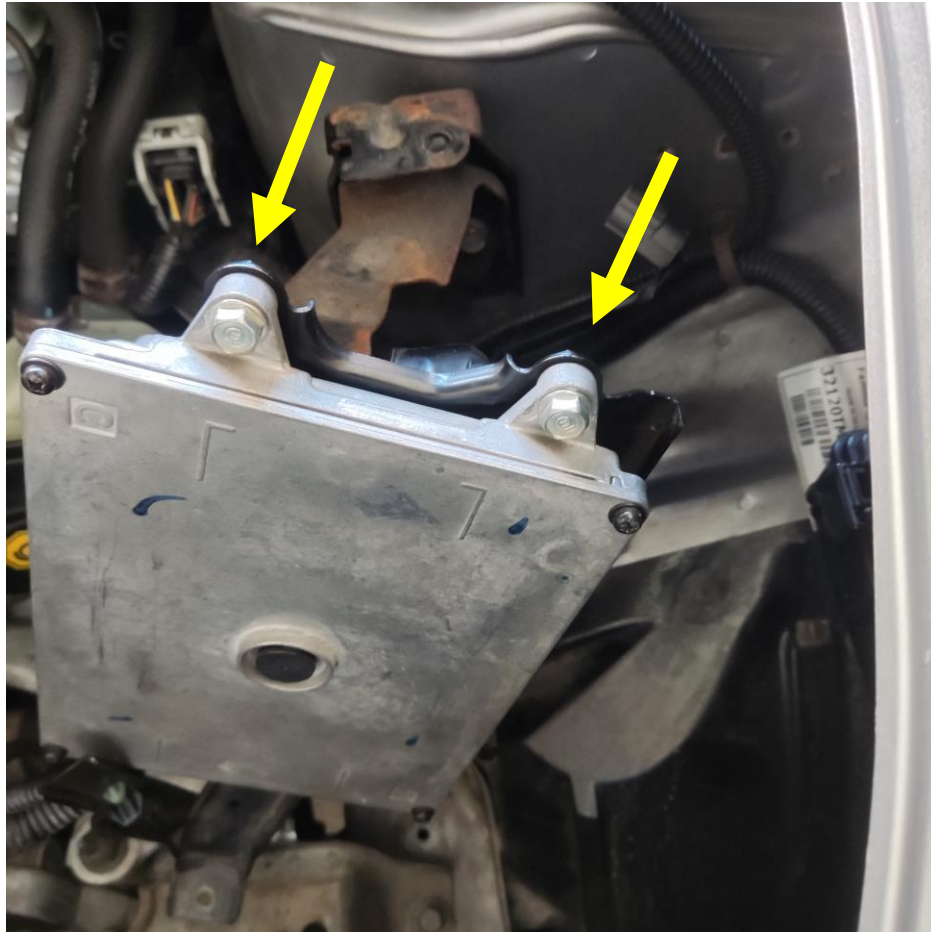

Instalação

19. Solte um pouco a porca indicada e puxe o Módulo do suporte.

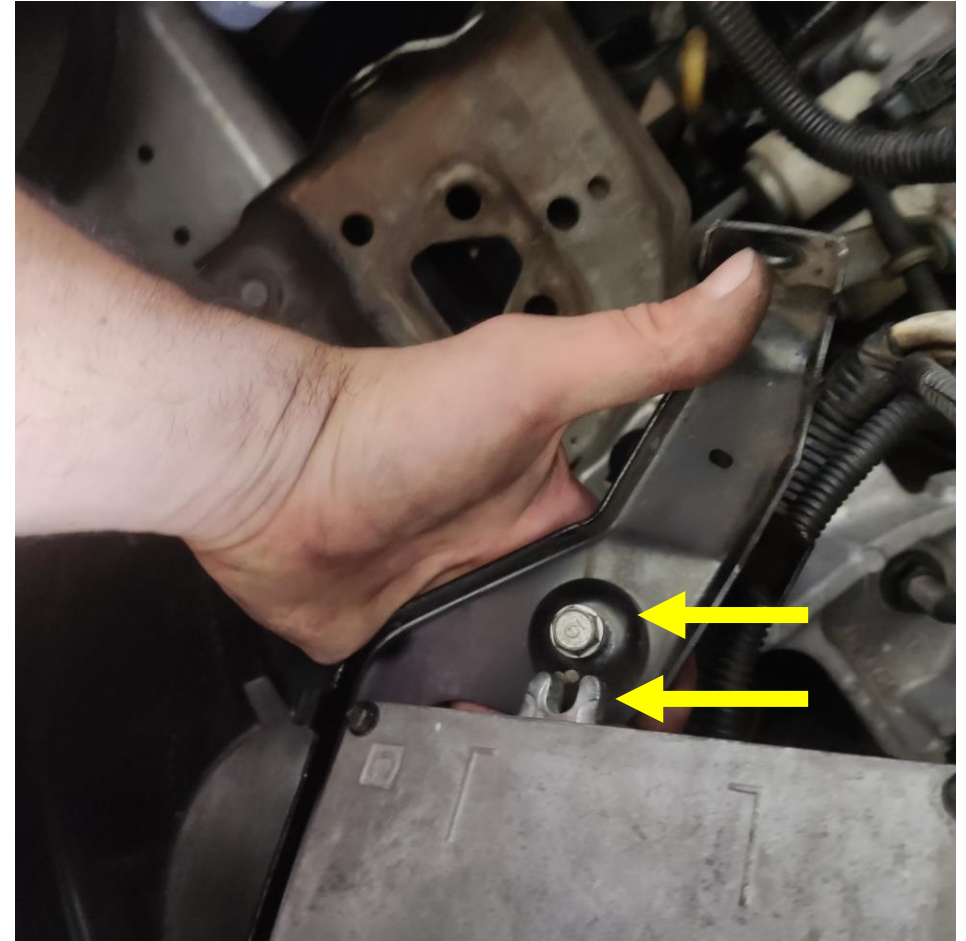
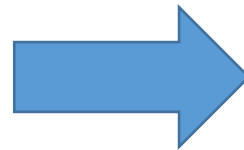

Instalação

20. Vista o Módulo com o cofre.

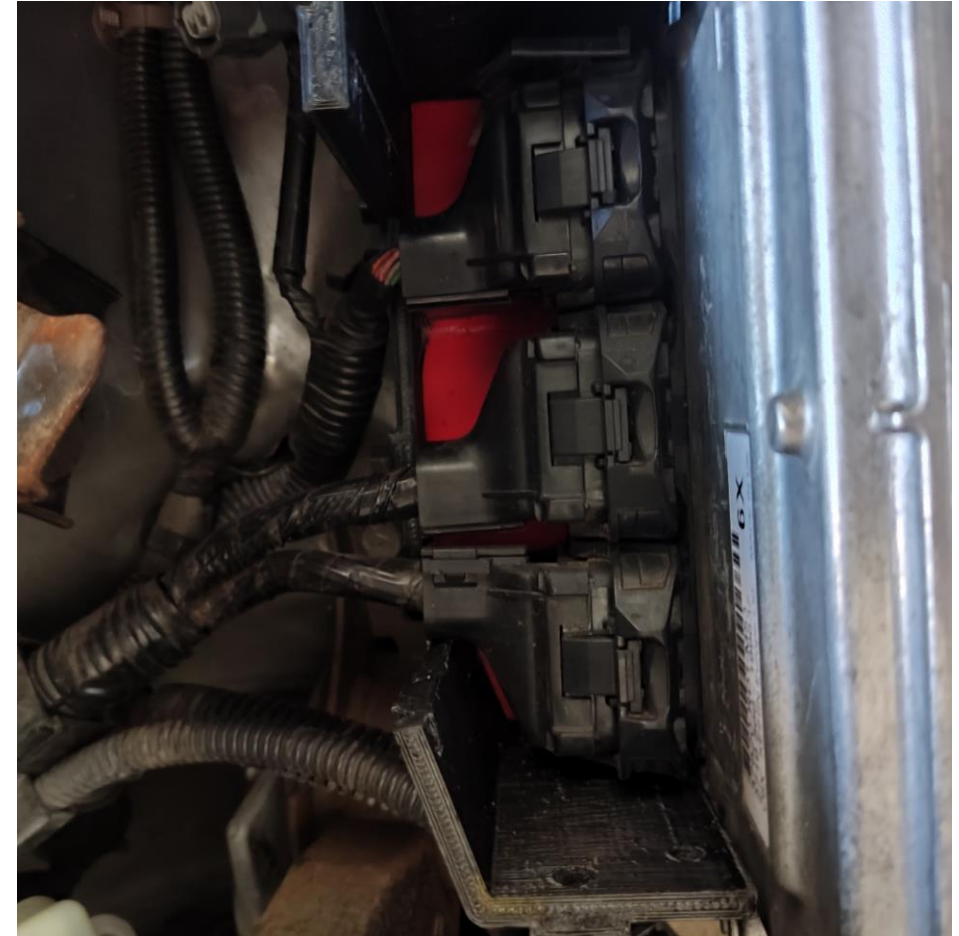
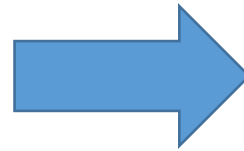
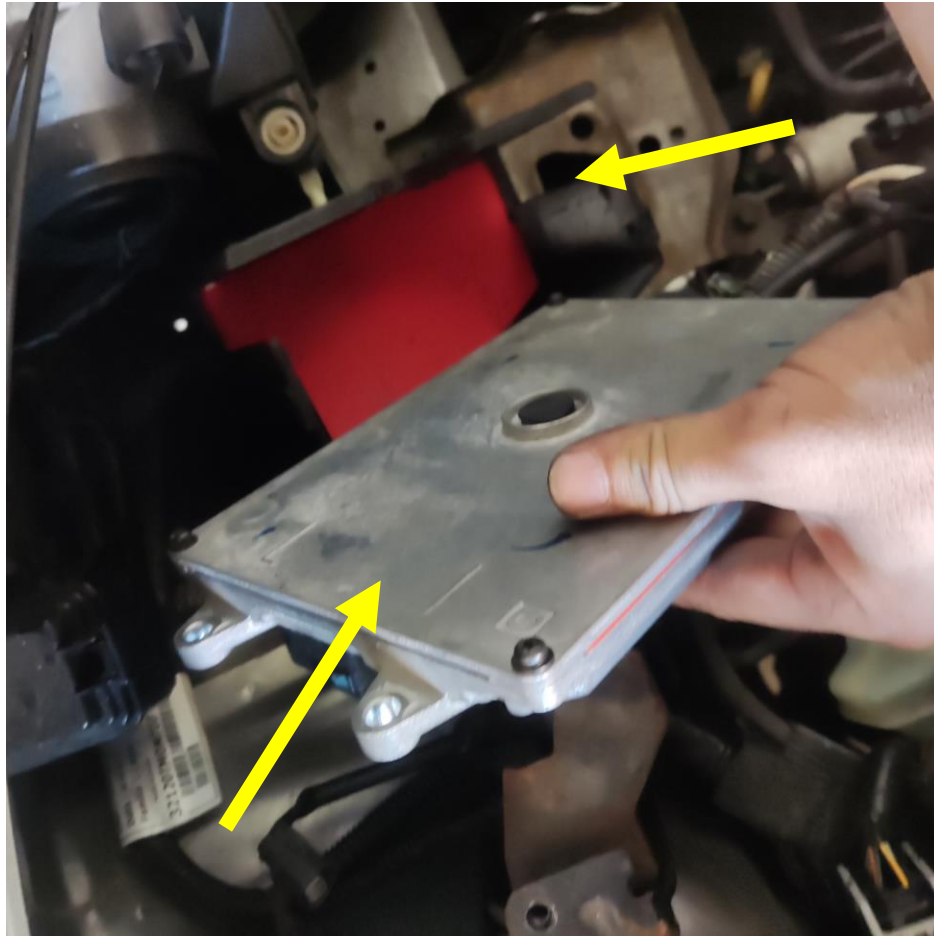

Instalação



21. Insira a segunda tampa no cofre, em cima dos conectores.

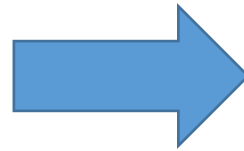
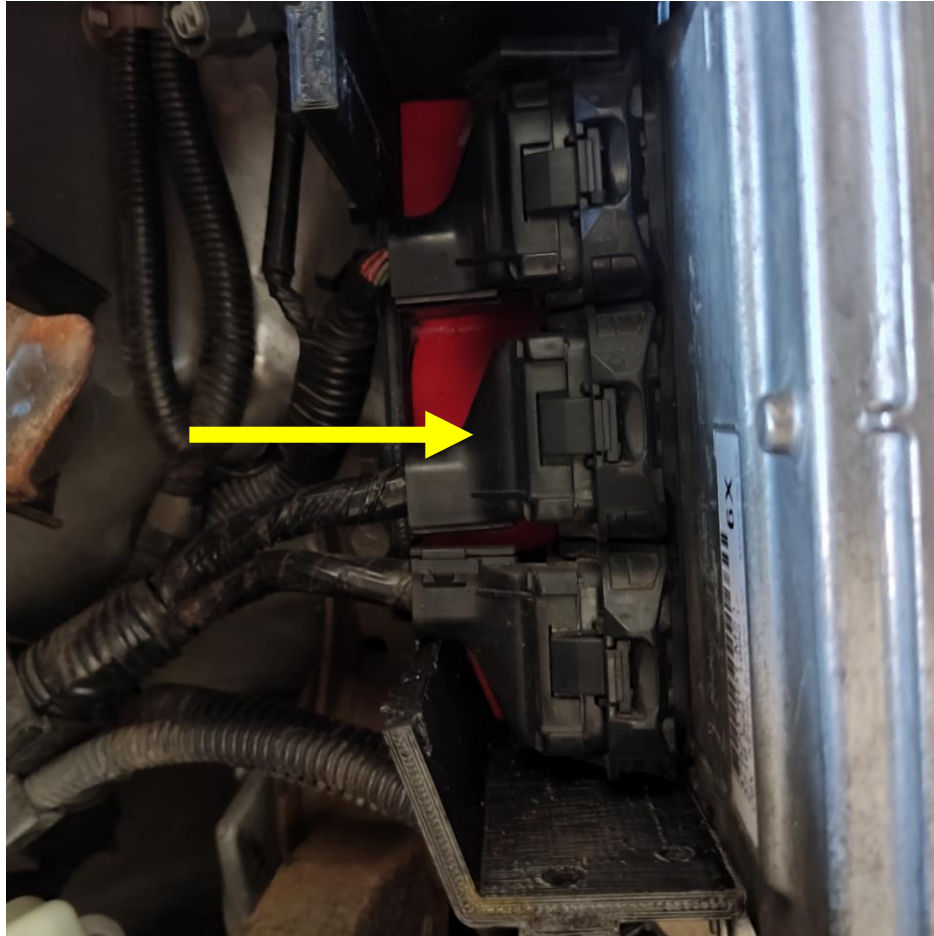

Instalação



22. Coloque os parafusos especiais na tampa **sem quebrar a cabeça.**

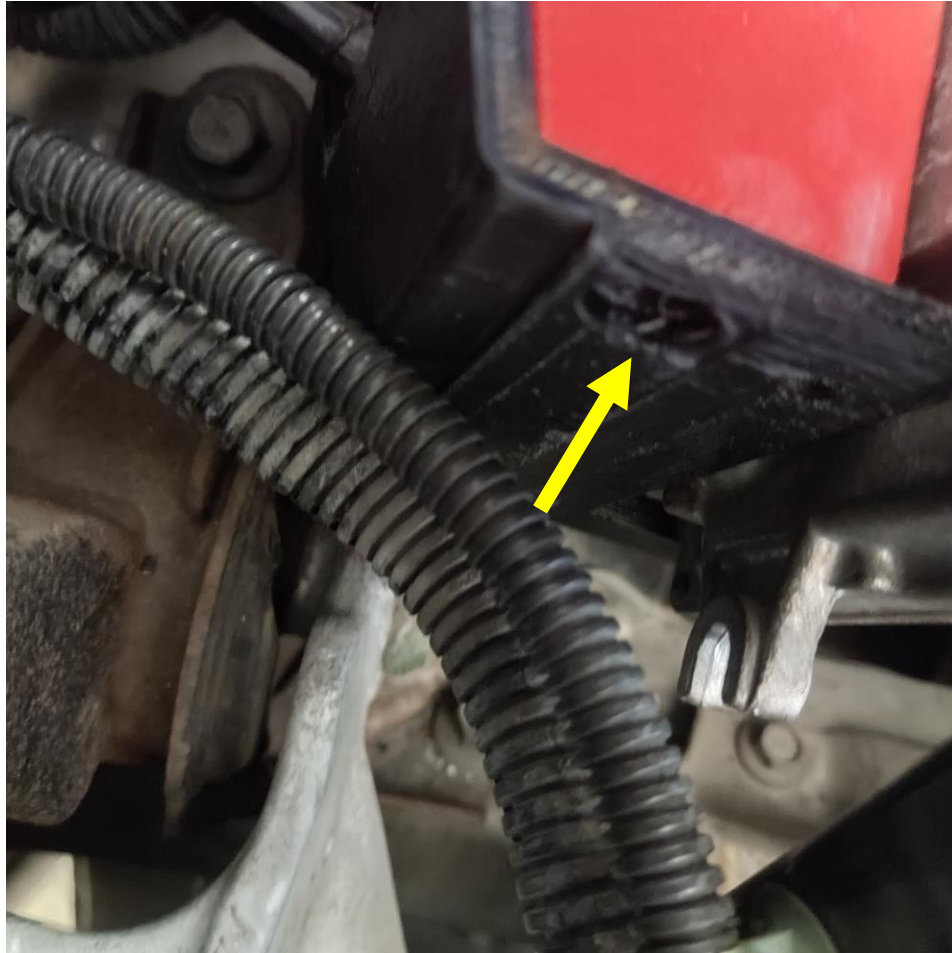

Instalação

23. Coloque a tampa complementar entre a tampa e o cofre.

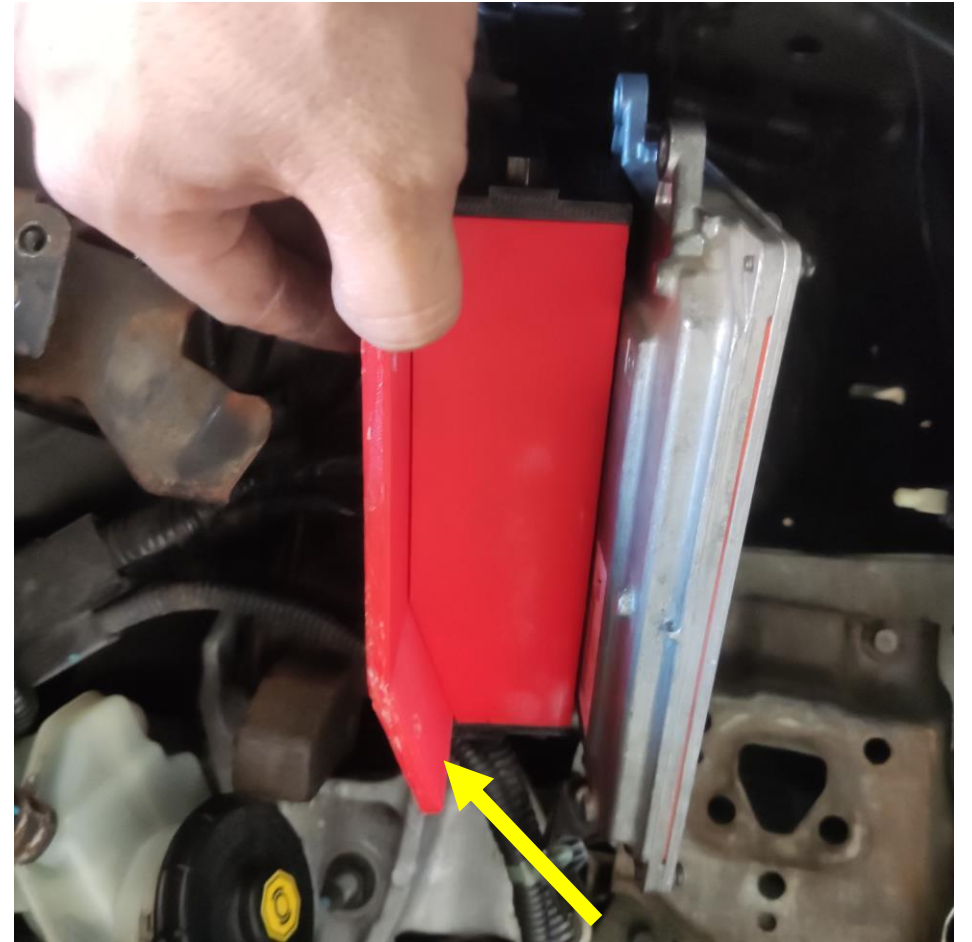
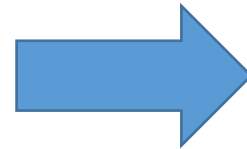
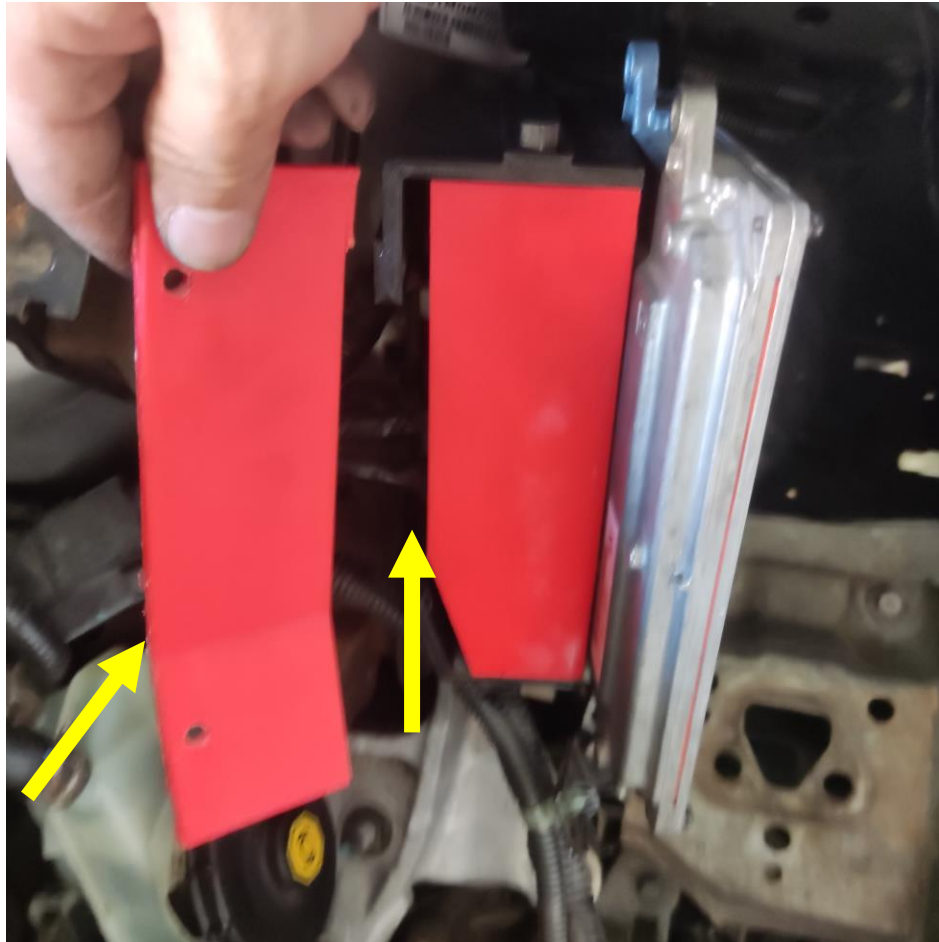

Instalação



24. O cofre tem que ficar desta maneira.



Instalação



25. Coloque os parafusos especiais sem quebrar a cabeça.



Instalação



26. Coloque o suporte do cofre no local onde foi retirado o suporte do módulo.

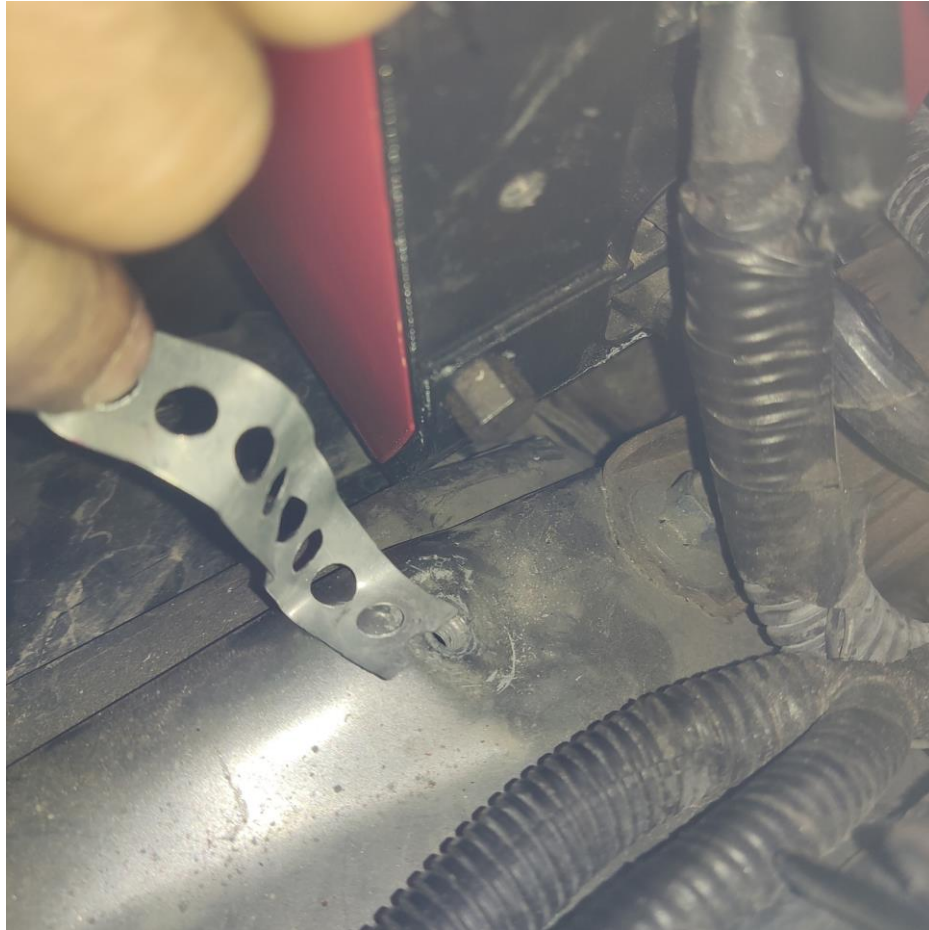

Instalação

27. Use o suporte para fixar o cofre no veículo.

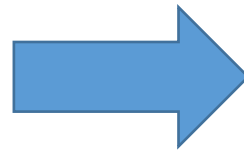

Instalação

28. Use o suporte para fixar o Módulo no veículo.

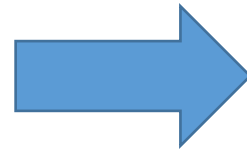

Instalação

29. Coloque o reservatório de freio.

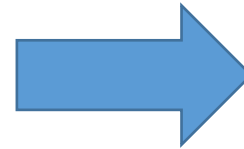

Instalação

30. Fixe o reservatório de freio como indicado.

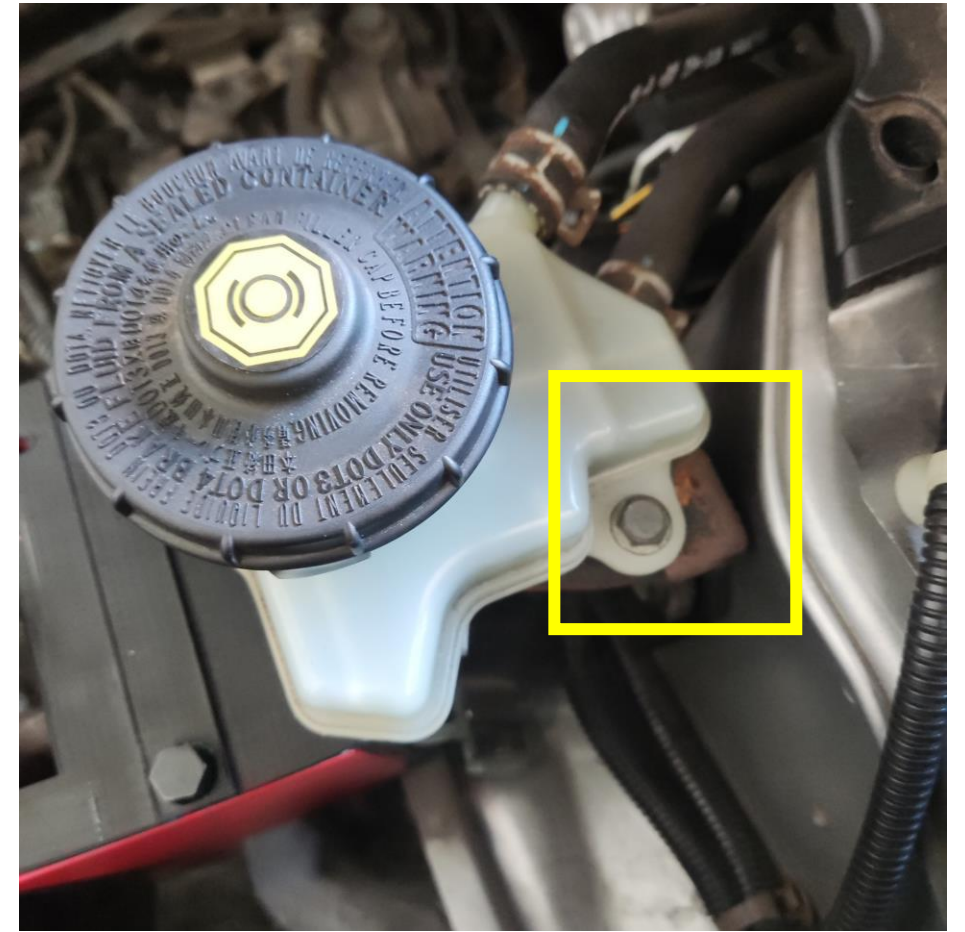
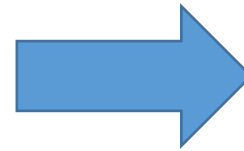

Instalação

31. Coloque o suporte da bateria.

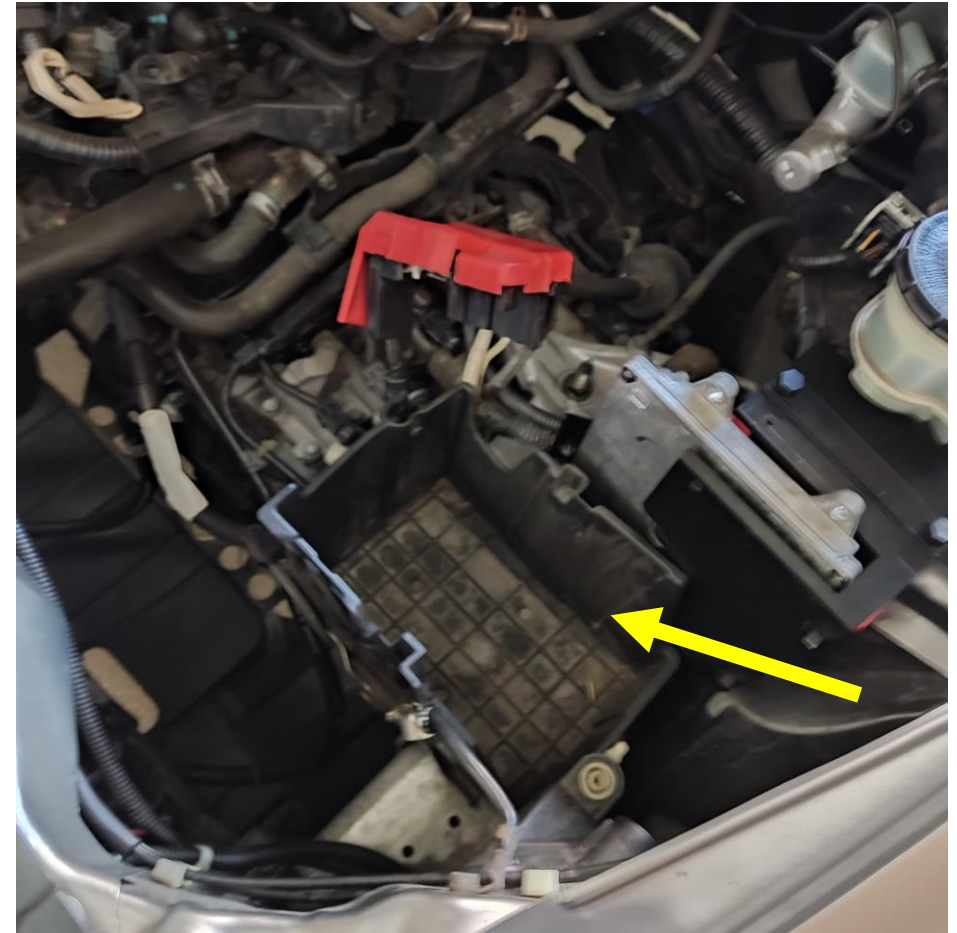
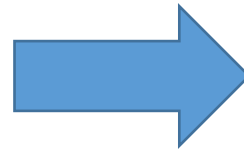
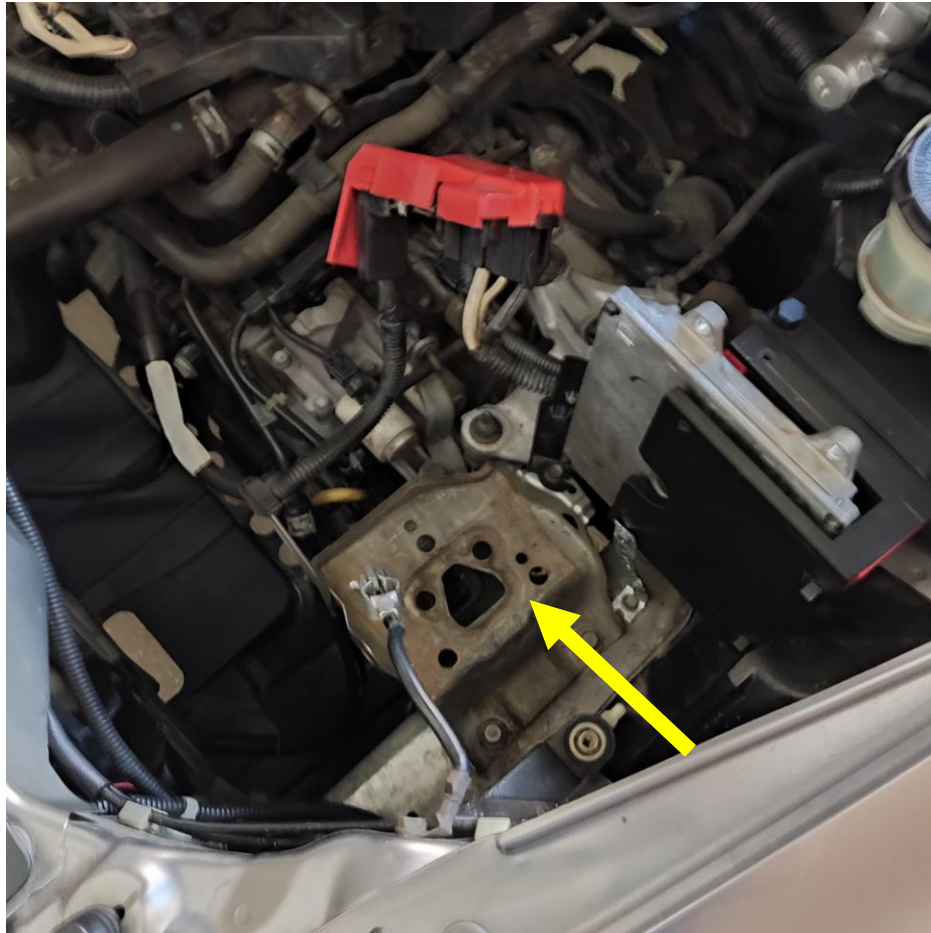

Instalação

32. Coloque a bateria no suporte.

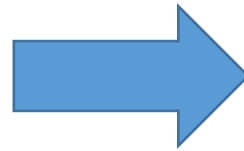

Instalação

33. Coloque o chicote do conector positivo (+) no suporte da bateria.

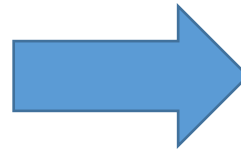
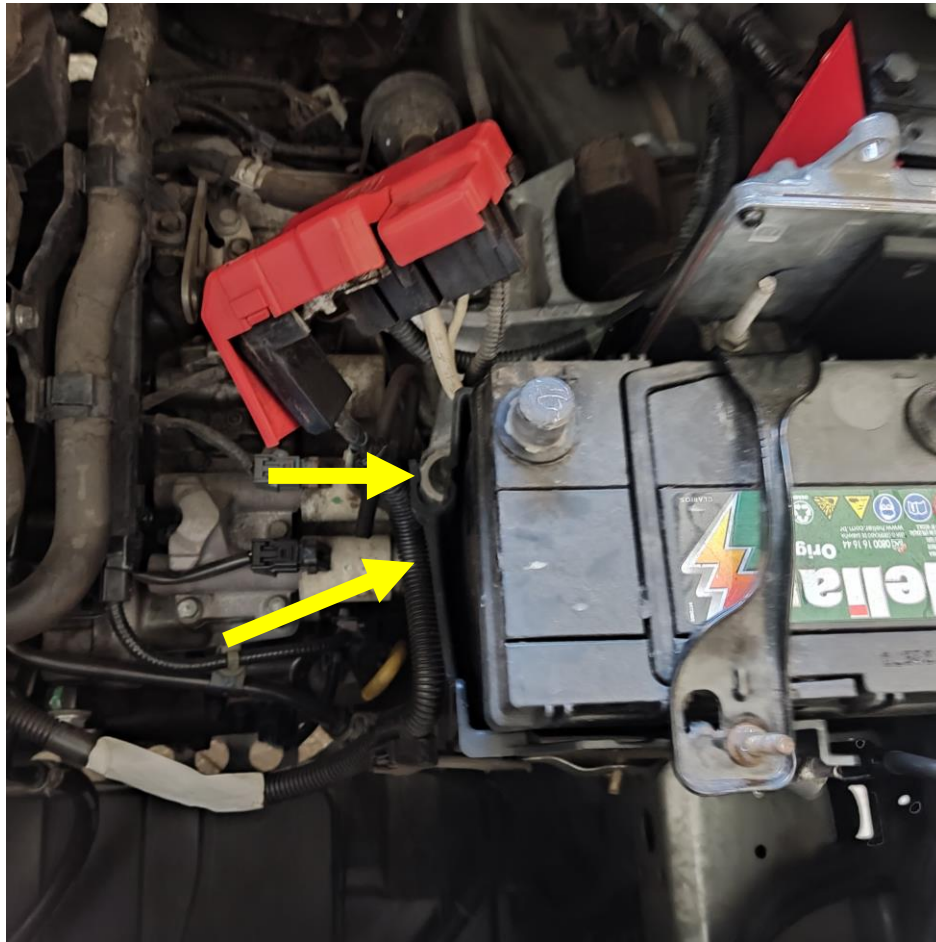

Instalação

34. Coloque o filtro de ar.

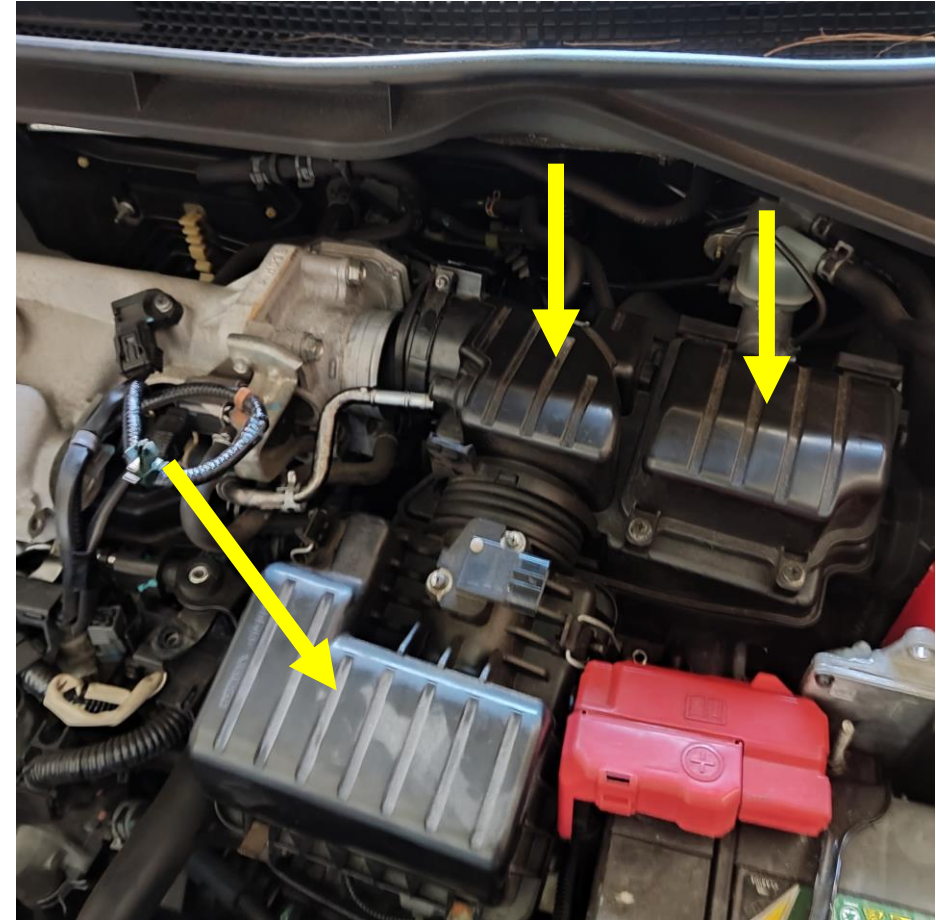

Instalação

35. Fixe o parafuso indicado.



Instalação

36. Fixe o parafuso indicado.

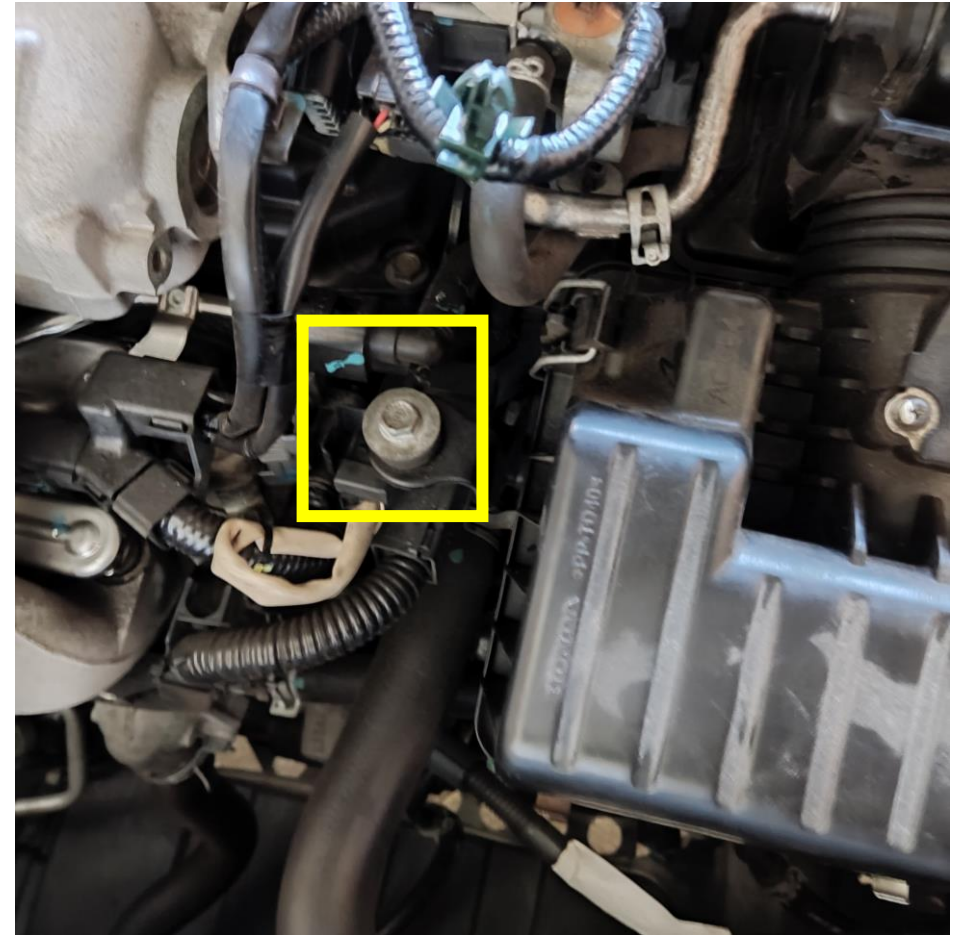
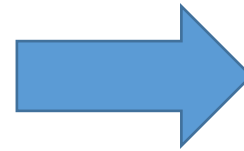
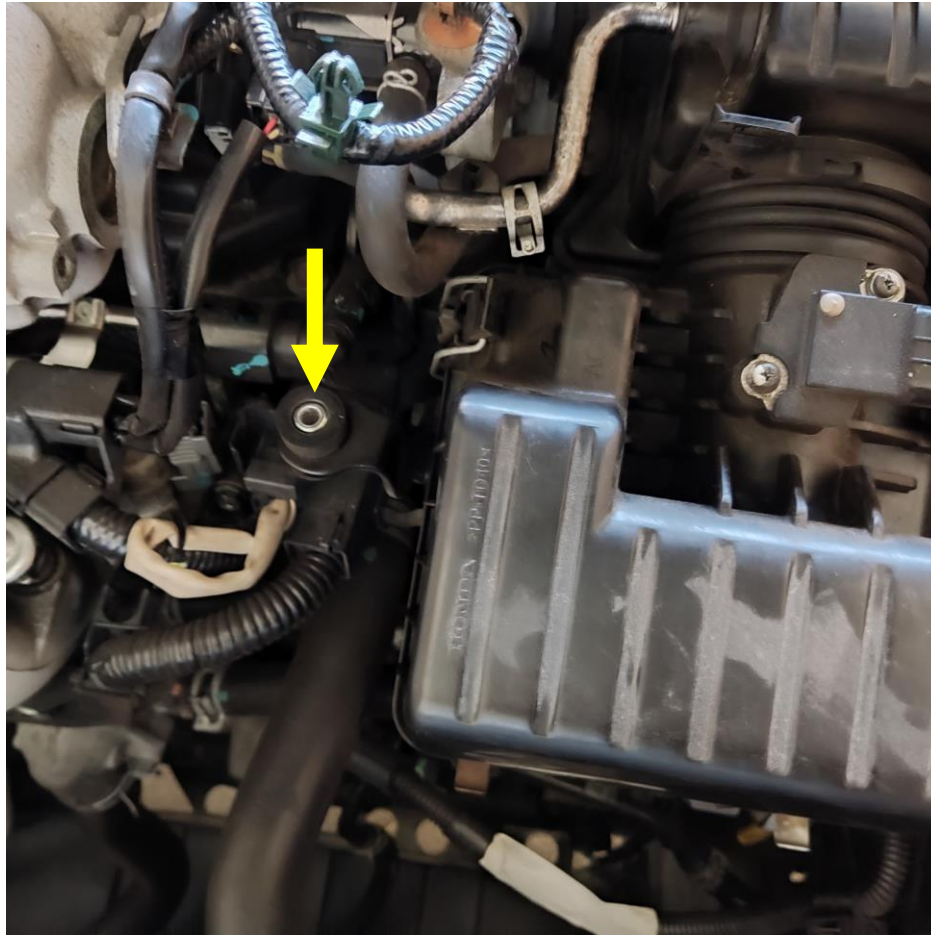

Instalação

37. Fixe o parafuso indicado.

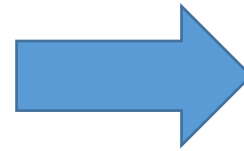

Instalação

38. Prenda a presilha de volta na tubulação.

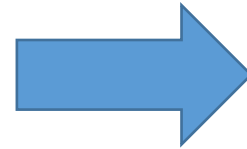
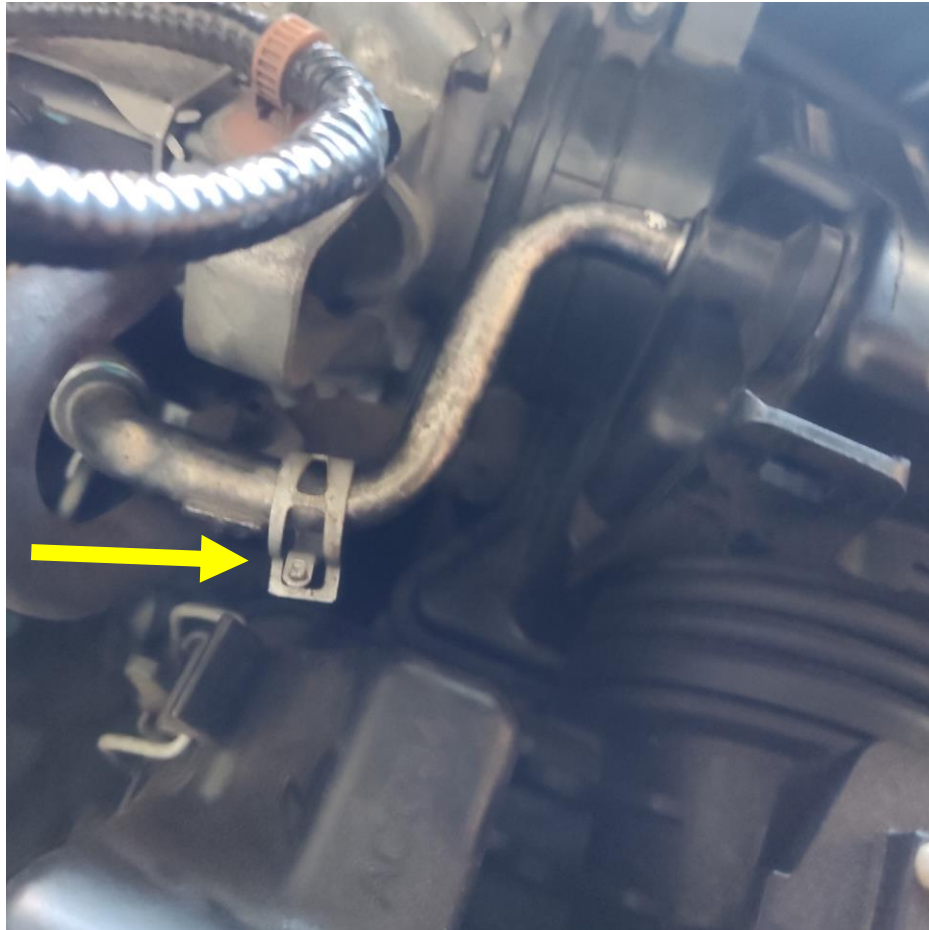

Instalação

39. Desenrole o chicote do sensor.

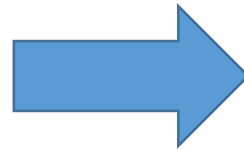

Instalação

40. Prenda a presilha do chicote de volta e coloque o conector do sensor

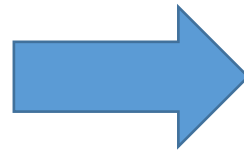

Instalação

41. Coloque a trava em cima da bateria e fixe.

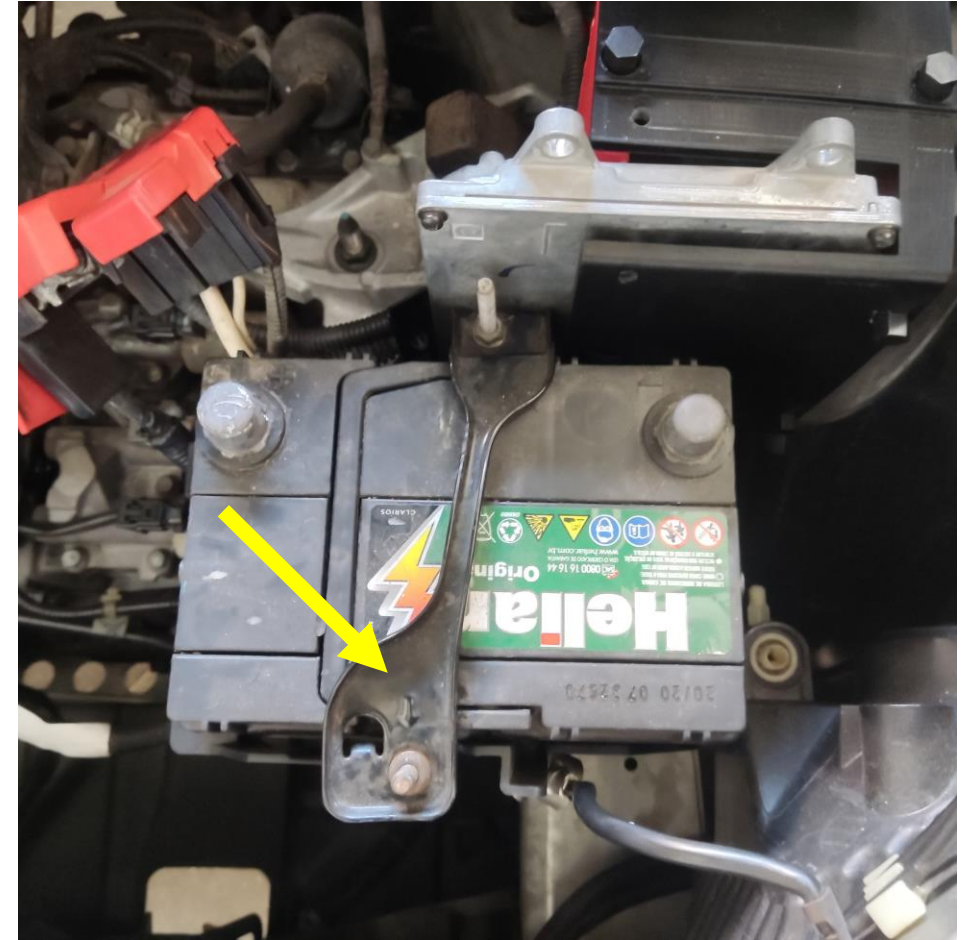
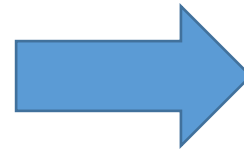

Instalação

42. Coloque o conector no polo positivo (+) da bateria.

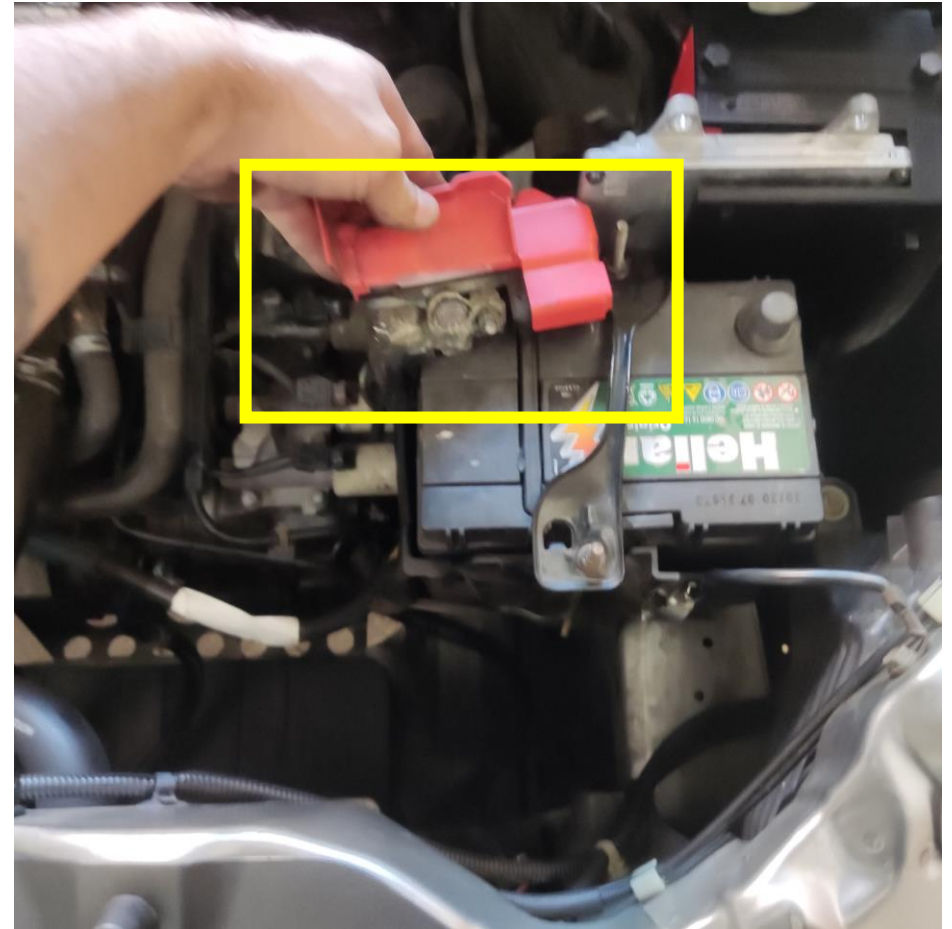
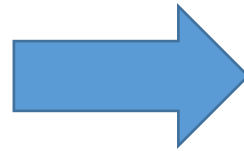
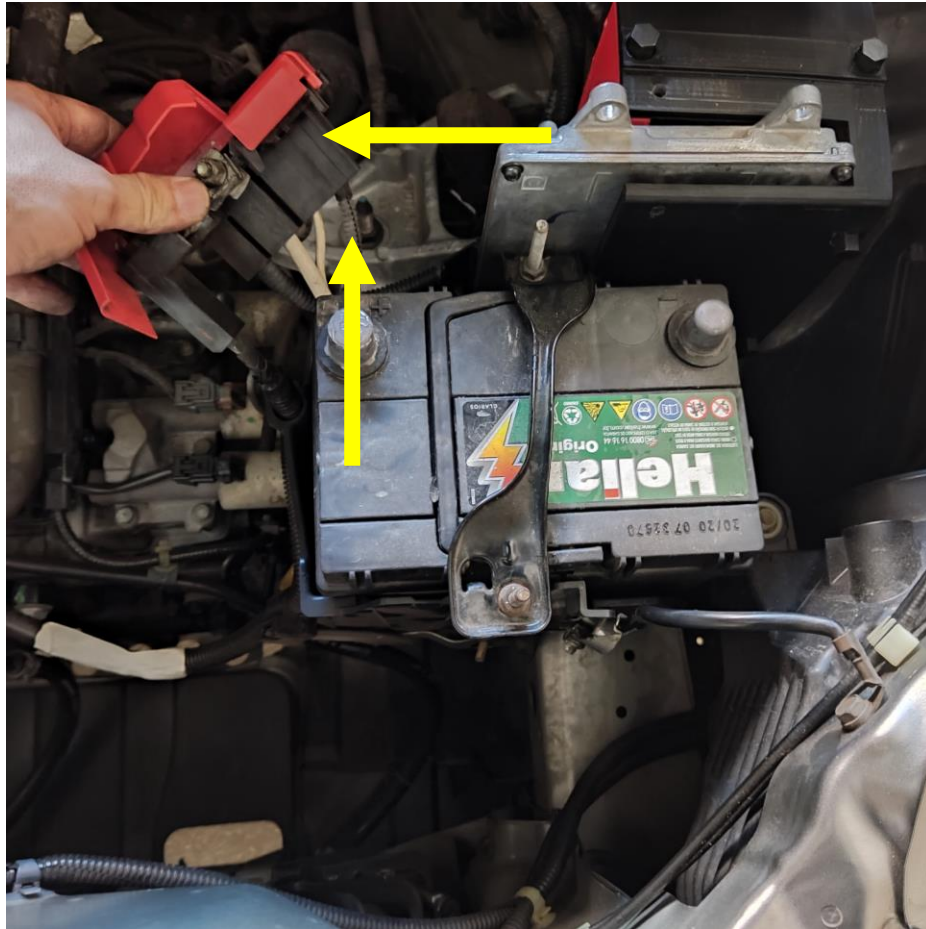

Instalação

43. Coloque o conector no polo negativo (-) da bateria.

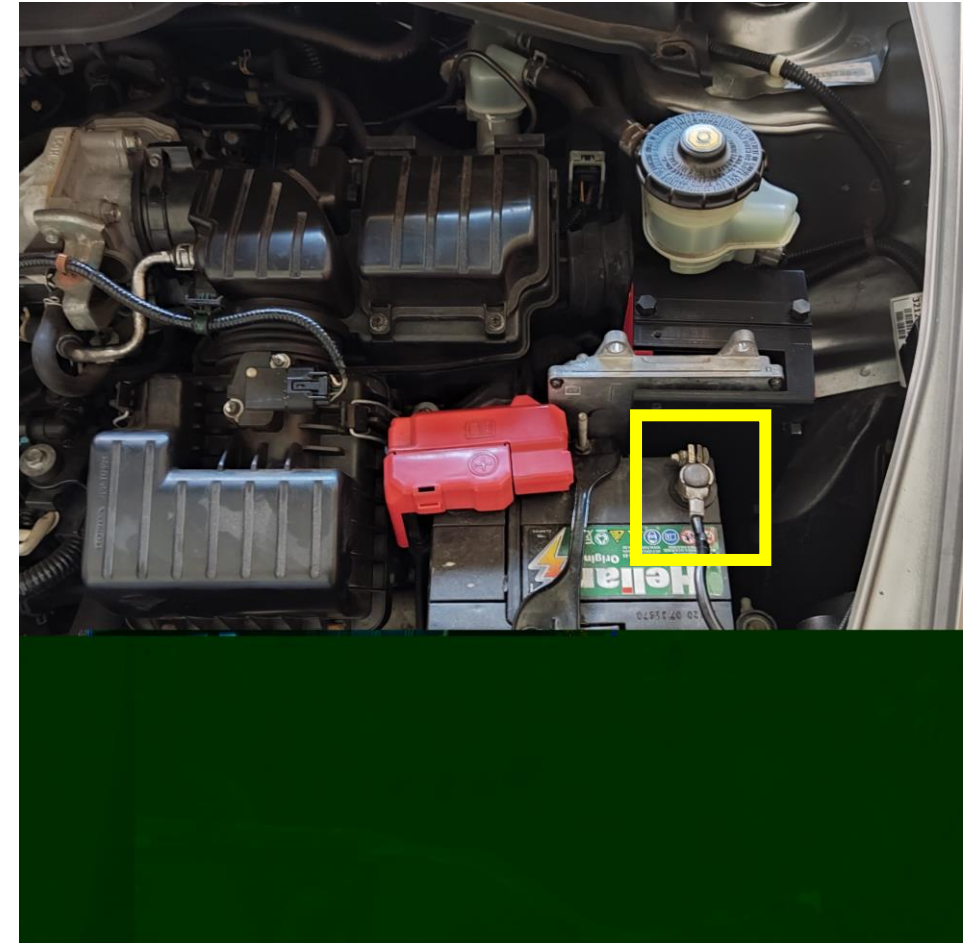
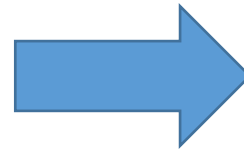
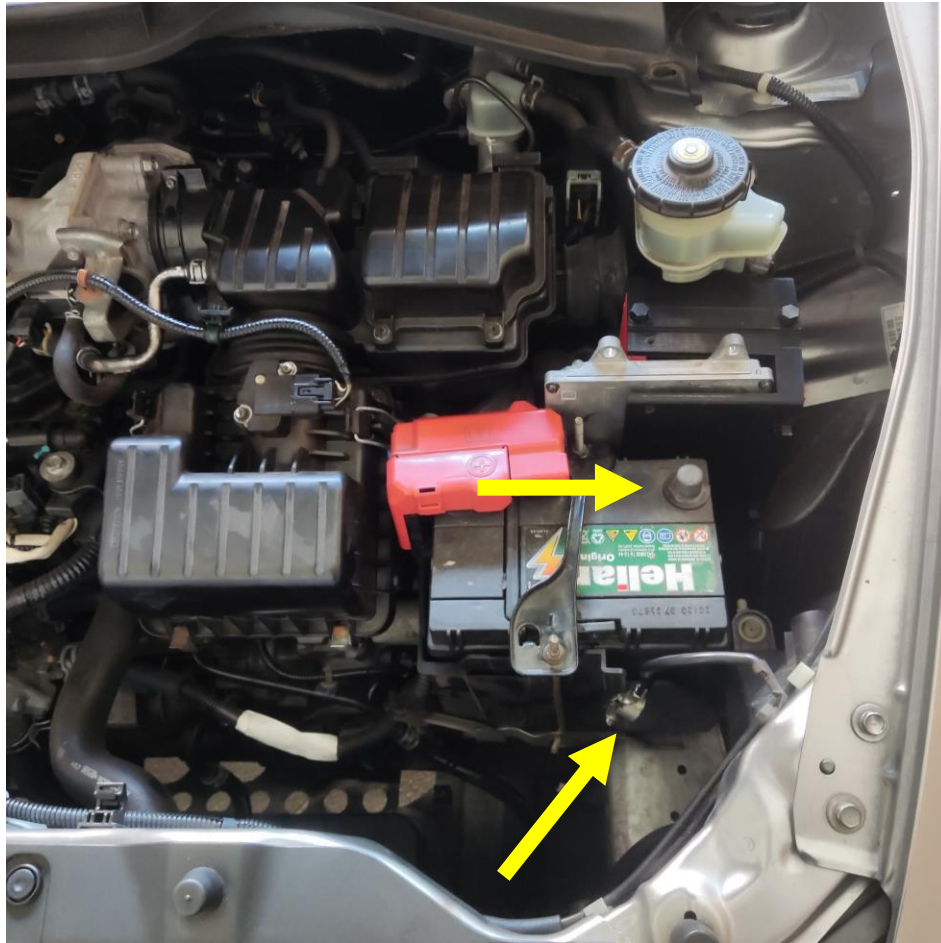

Instalação

44. Instalação finalizada.



Observação



1. Antes de finalizar a instalação e quebrar os parafusos, ligue o veículo e veja se aparece alguma luz de defeito no painel. Caso apareça algum sinal de defeito, **PARE** agora e tente desconectar e reconectar o plugue do ECU.

Quando todos os problemas forem resolvidos, pode prosseguir com a instalação do cofre quebrando os parafusos especiais e certificando-se de remover as cabeças dos parafusos do cofre do motor.

Observação



Obs. 1. Para quebrá-los, basta continuar com o aperto até o rompimento.

Obs. 2. Tire todas as cabeças que foram quebradas dos parafusos, garanta que não fique nada no compartimento do motor, assim evitando avaria aos demais componentes.

Obs. 3. Cuide para que não seja perdido e não tenha peças vibrando ou encostando em outras partes do veículo.

Depois de quebrar os parafusos especiais, prossiga com a instalação.

Atenção



- Esse produto, bem como seu manual de instalação, foram desenvolvidos por profissionais técnicos;
- A SAFECAR não se responsabiliza por nenhum dano, seja físico ou financeiro, causado pelo uso incorreto do produto ou das instruções;
- Em caso de dúvida ou comentário, entre em contato conosco: tecnico@safecar.net.br



SAFECAR

ESPECIALISTA CONTRA CRIMES AUTOMOTIVOS

Safecar Brasil Importação, Exportação e Participações Ltda.
Rua Eliseu de Oliveira, 40 – Cidade Monções – São Paulo – SP
Tel. (11) 5505-1548
www.safecar.biz