

# Guia de instalação SAFECAR – Pulse



**SAFECAR**

ESPECIALISTA CONTRA CRIMES AUTOMOTIVOS

# Atenção

---



- A instalação deve ser feita somente por profissionais autorizados;
- Ligar o carro para garantir que não exista nenhuma luz indicando defeito no painel;
- Caso tenha alguma luz de defeito acesa, informe o cliente antes do início da instalação;
- Aguarde 15 minutos após o desligamento do veículo para iniciar o processo de instalação;
- Não desmonte qualquer peça do veículo que não apareça neste guia;
- Ao final da instalação devolva as chaves do veículo onde as pegou.

# Componentes do Cofre Blindado

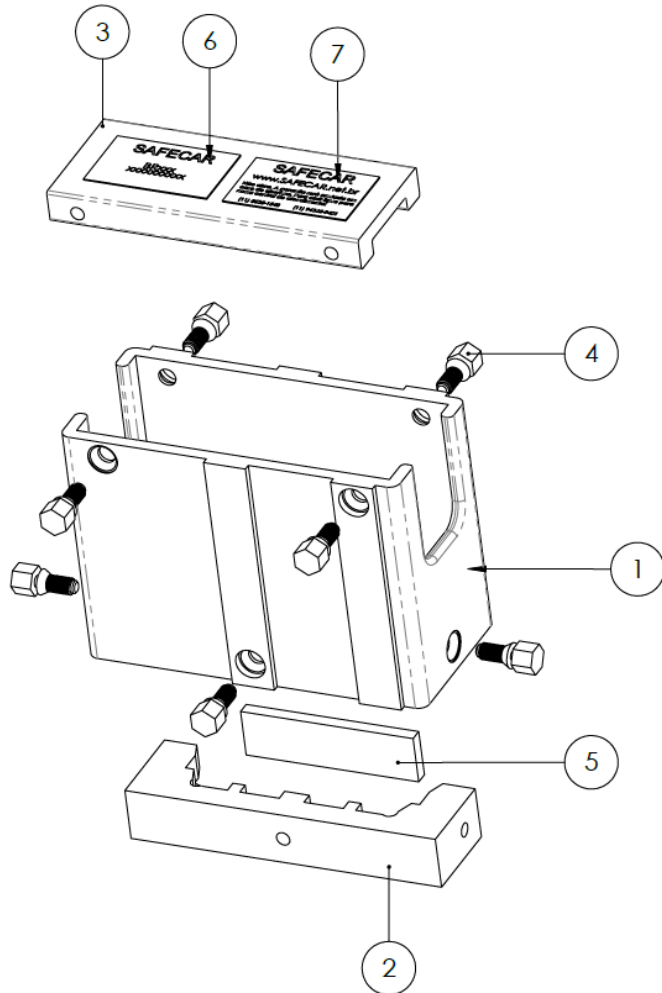

| Nº DO ITEM | Nº DA PEÇA         | QTD. |
|------------|--------------------|------|
| 1          | Cofre              | 1    |
| 2          | Trava              | 1    |
| 3          | Tampa              | 1    |
| 4          | Parafuso especial  | 7    |
| 5          | Fita espuma 19 x 5 | 1    |
| 6          | Etiqueta PRODUTO   | 1    |
| 7          | Etiqueta SAFECAR   | 1    |

# Instalação

1. Retire as porcas e o chicote indicados.

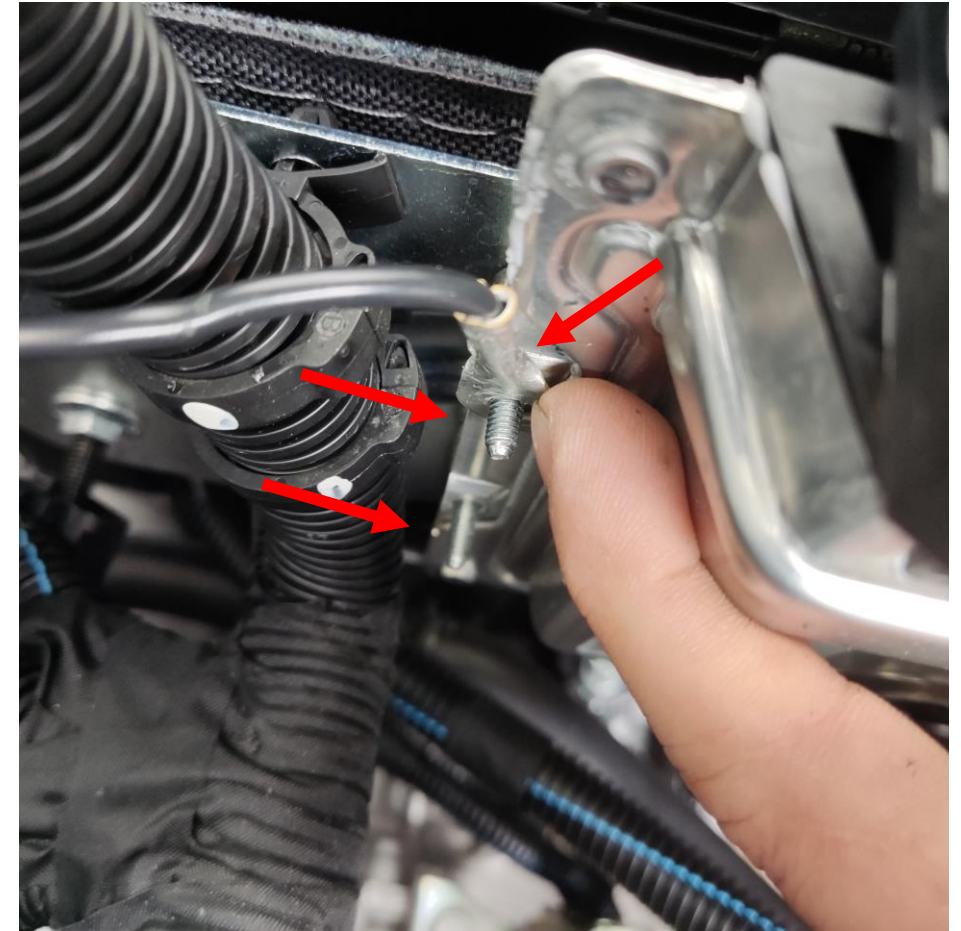

# Instalação

2. Retire as porcas indicadas.

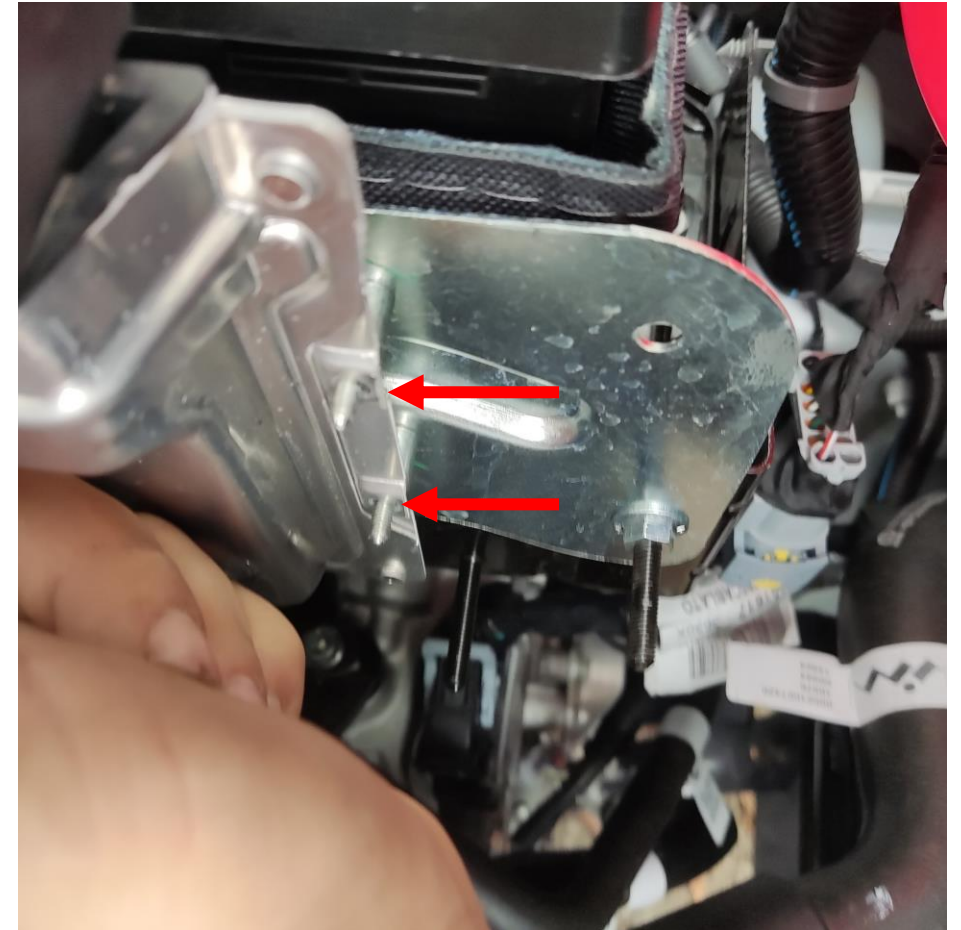
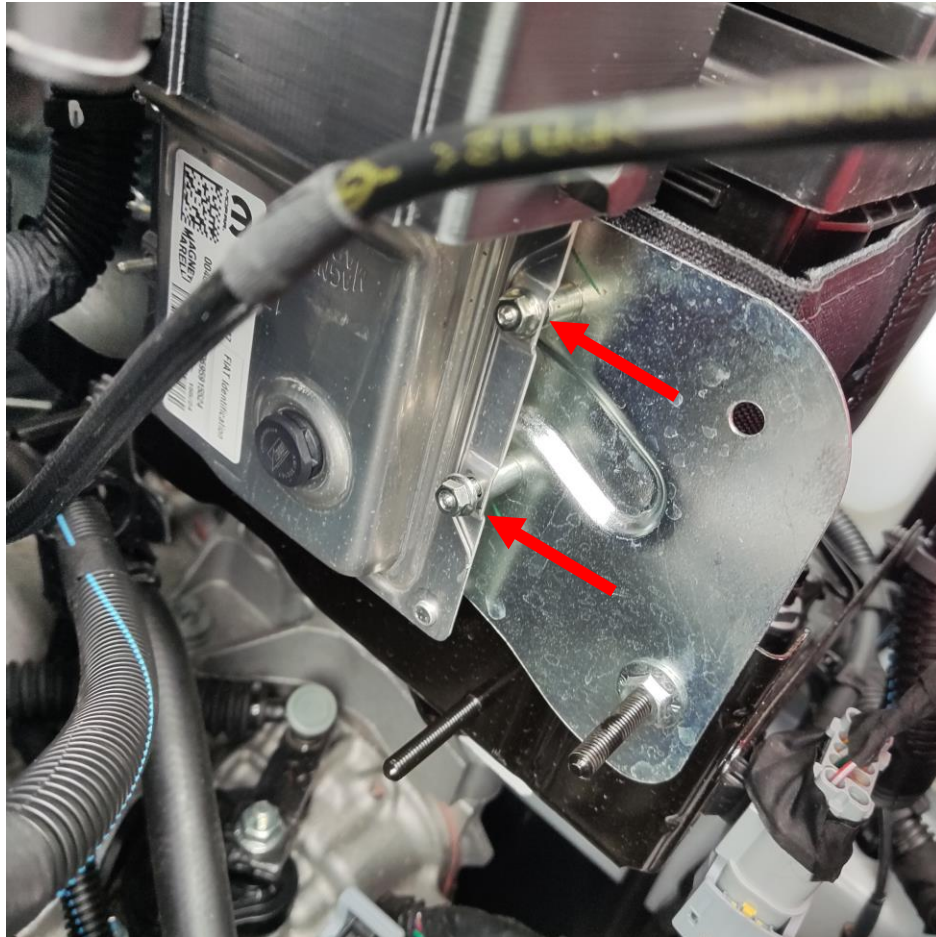



# Instalação

4. Coloque a trava no local indicado.

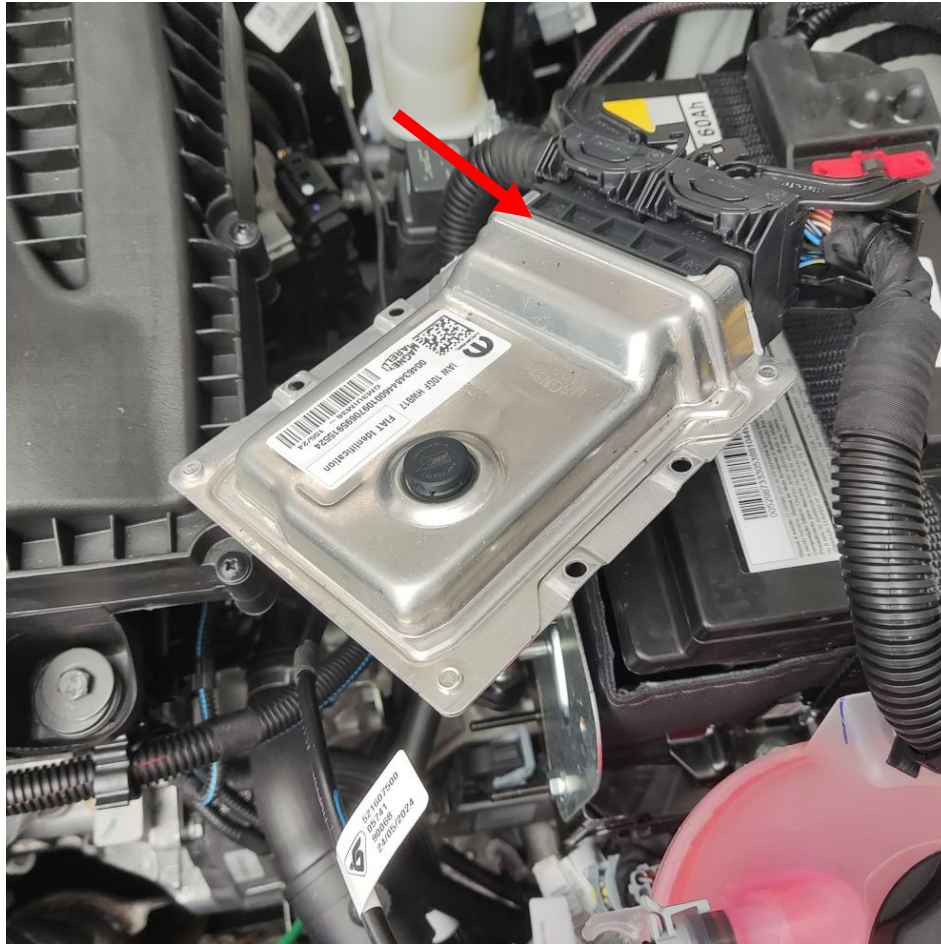

# Instalação

5. Vista o módulo com o cofre.

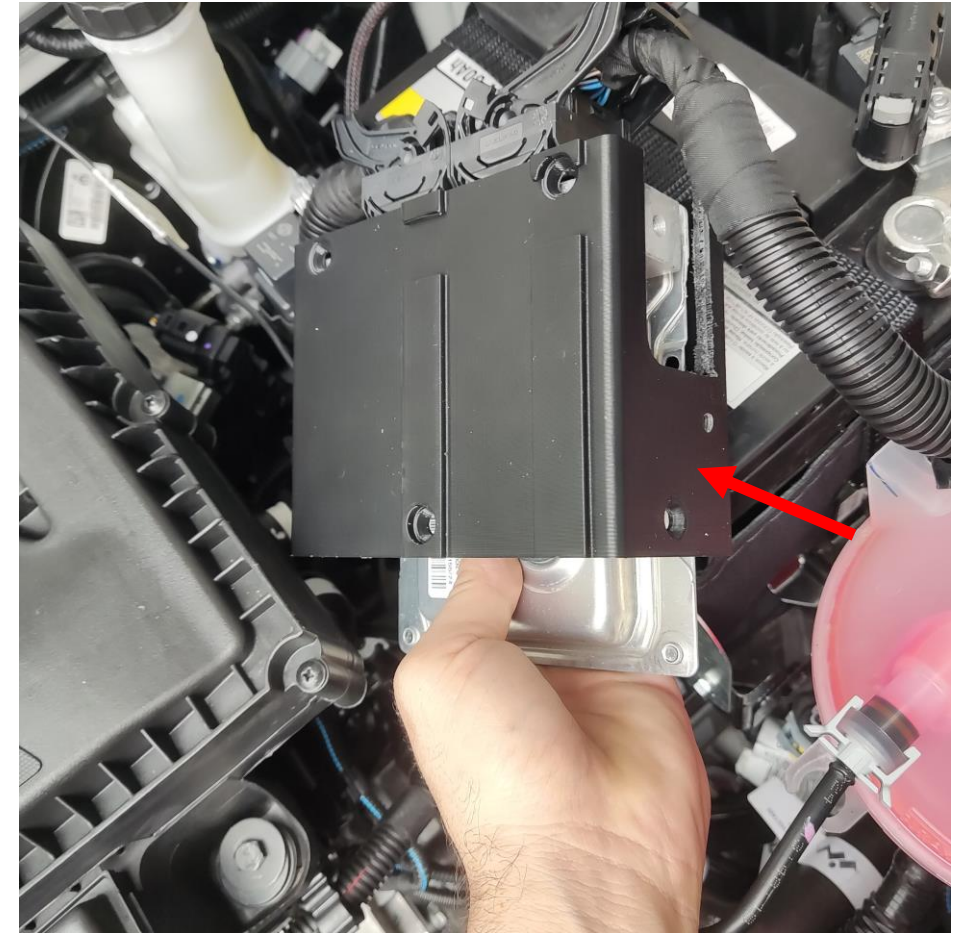
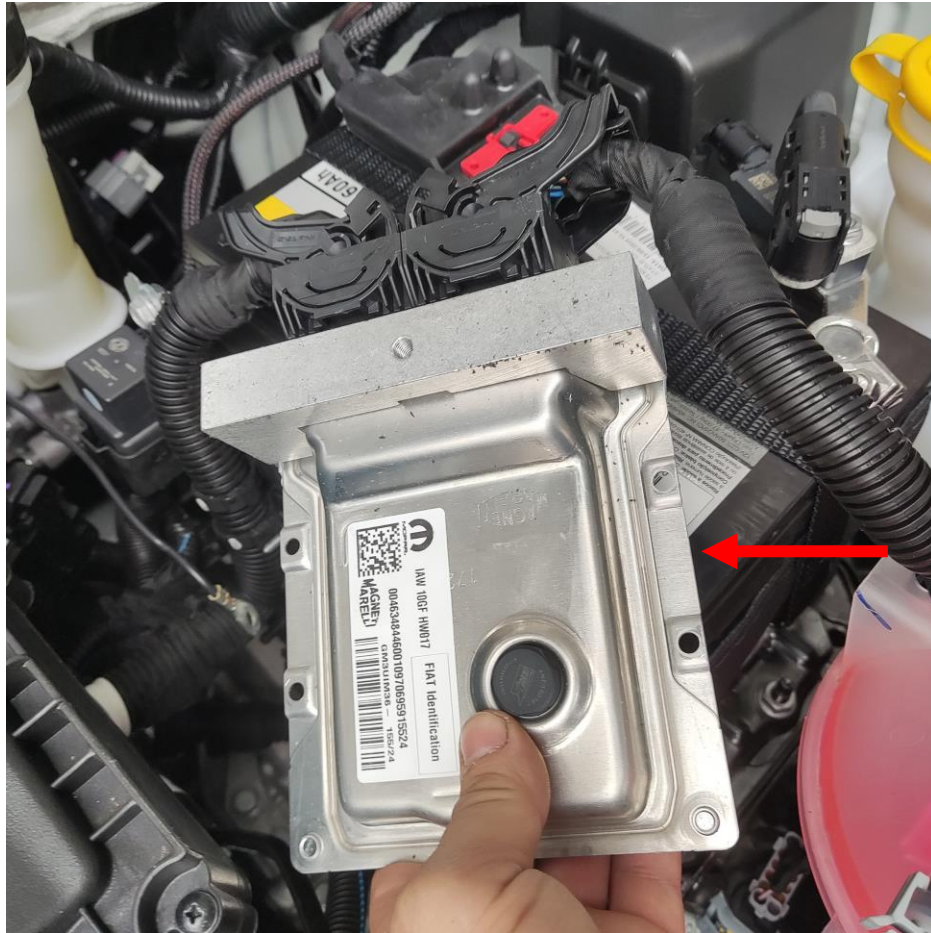

# Instalação

6. Suba o cofre até alinhar as furações do cofre e trava.

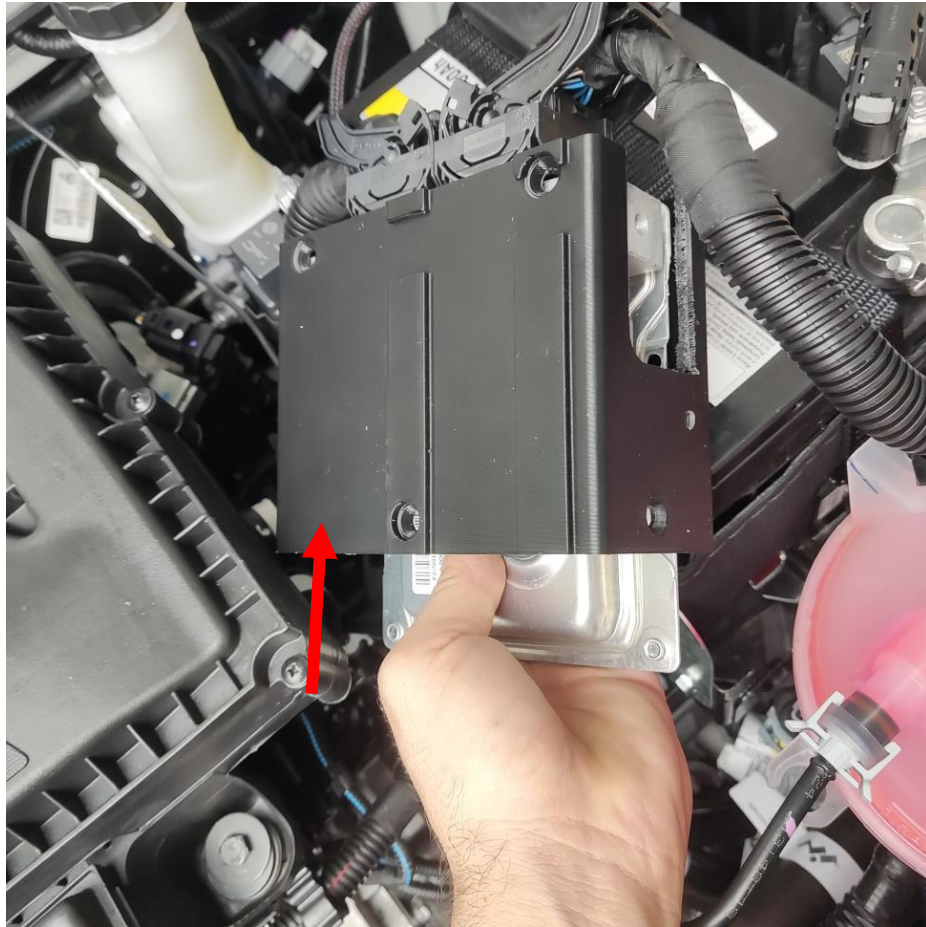

# Instalação

7. Coloque os parafusos especiais mas **NÃO** quebre a cabeça ainda.

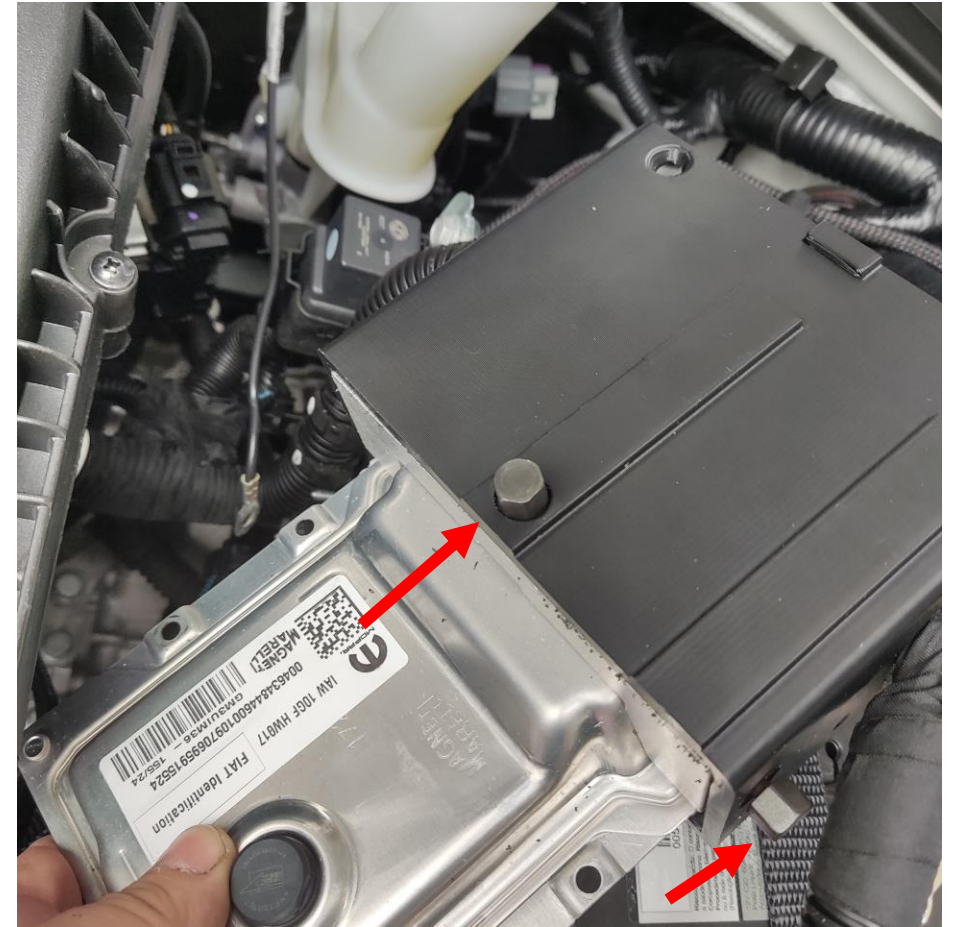

# Instalação



8. Coloque o cofre no suporte.



# Instalação

9. Coloque as porcas e o chicote indicados.

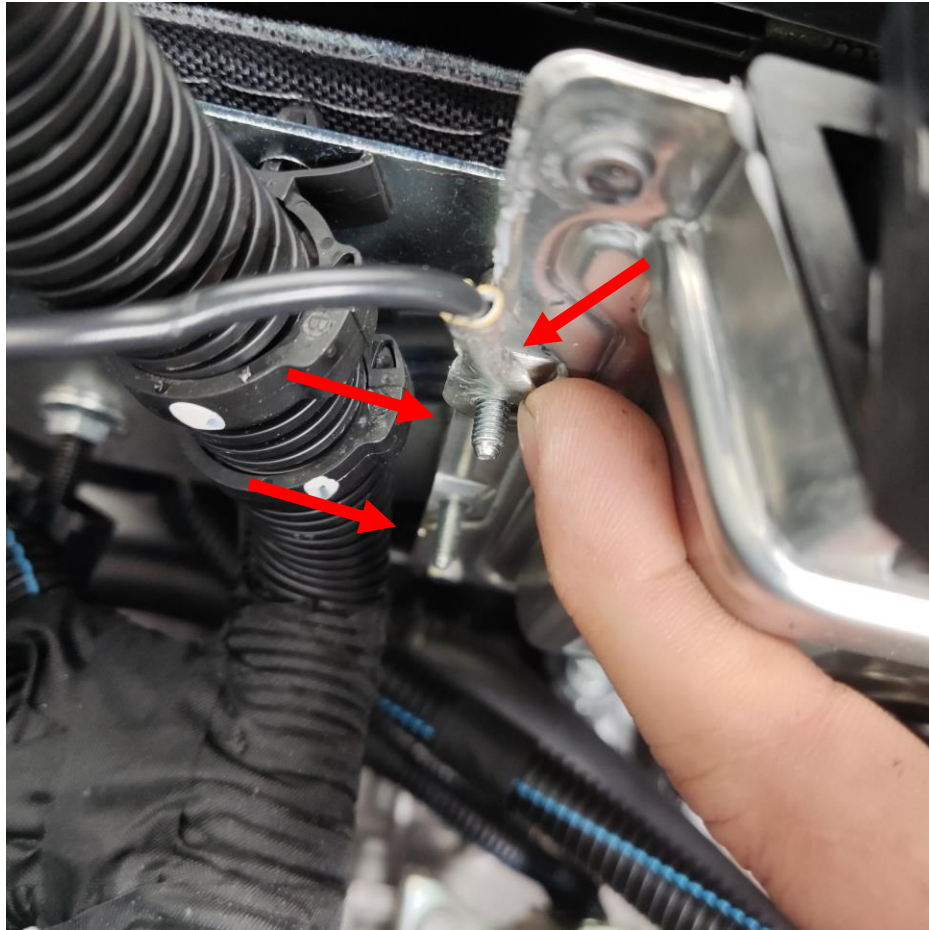

# Instalação

10. Coloque as porcas indicadas.

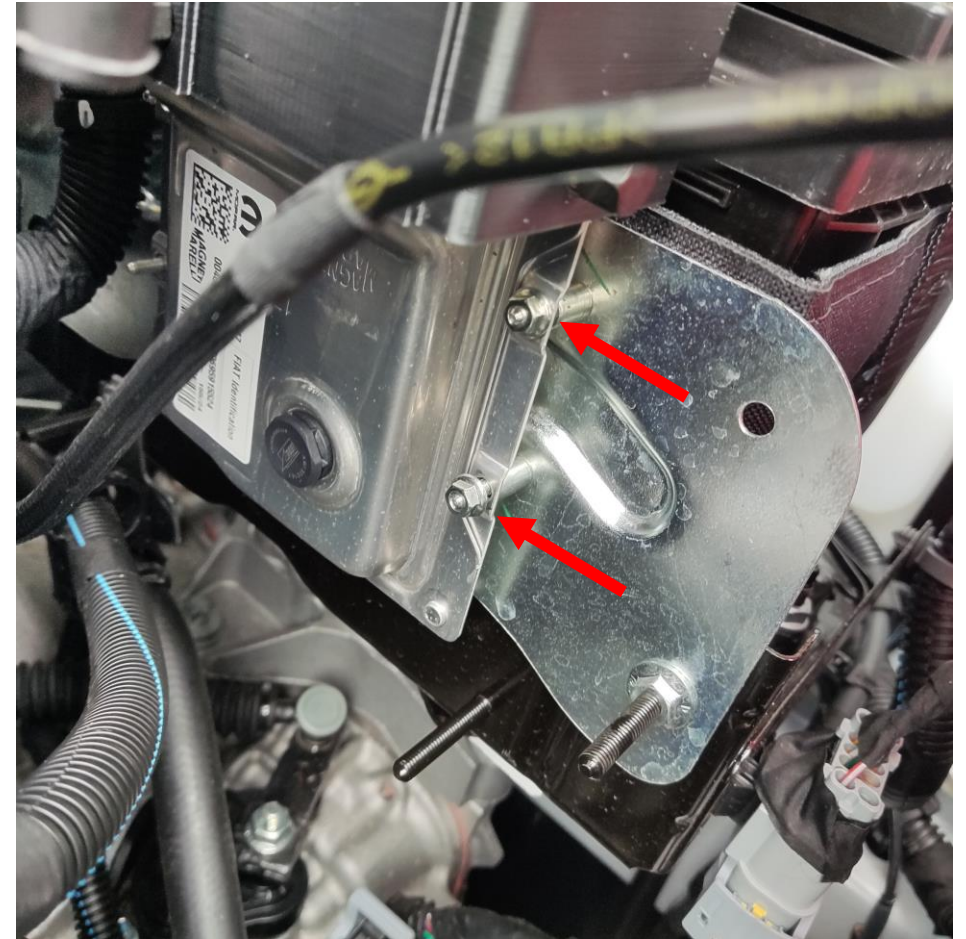
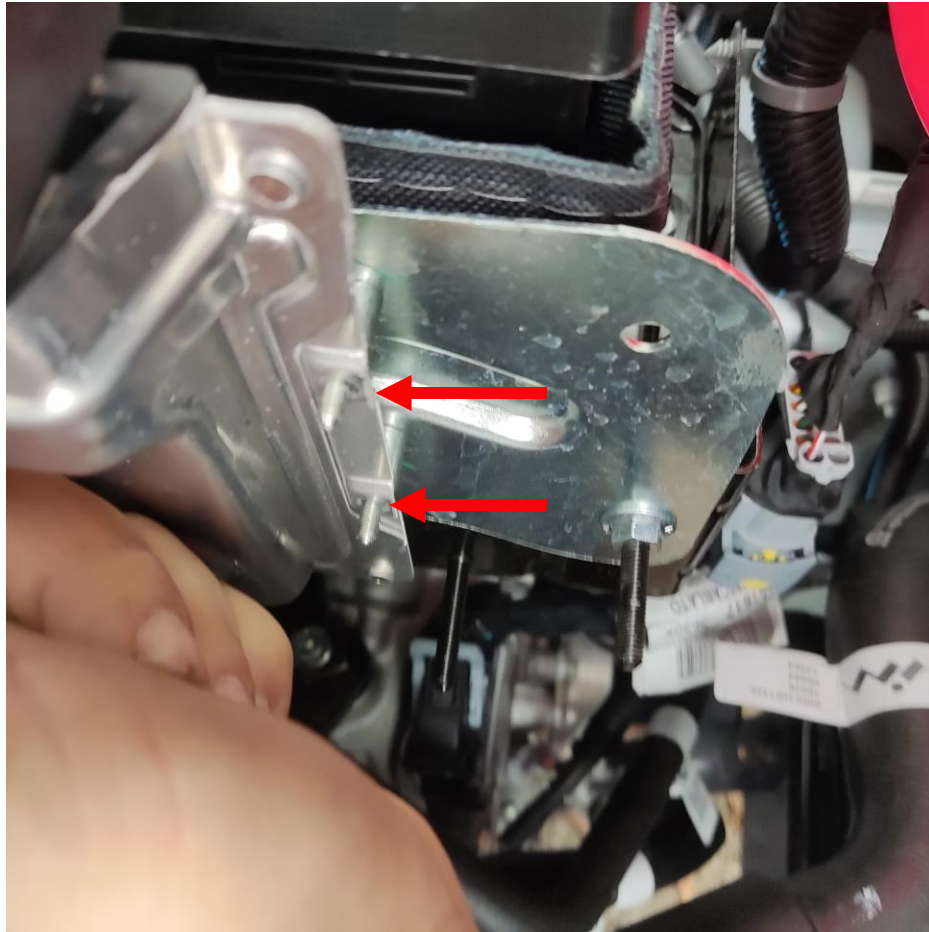

# Instalação

11. Coloque a tampa do cofre.

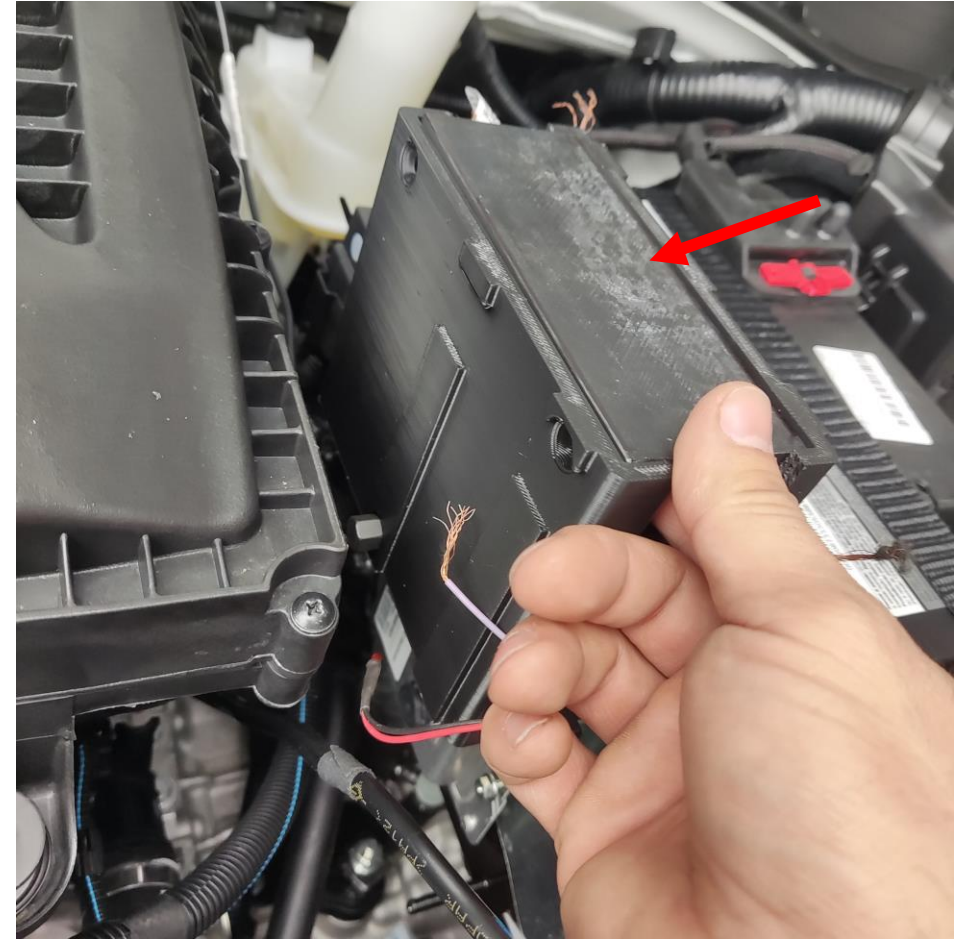
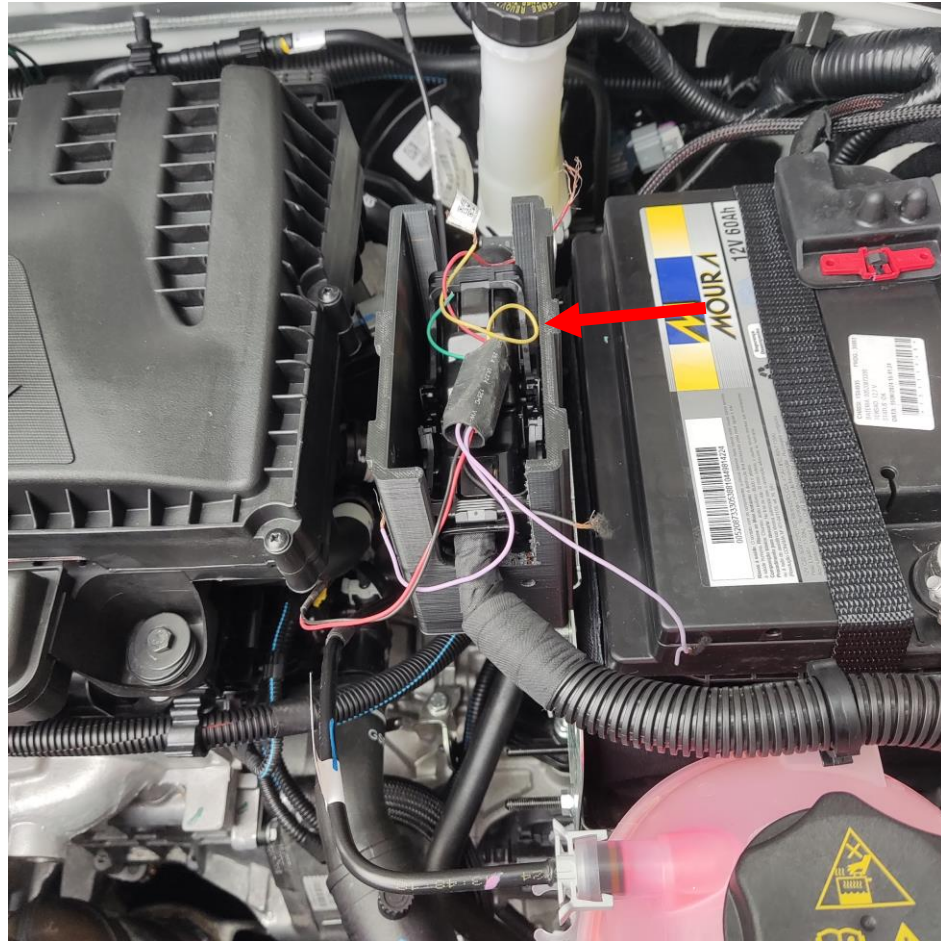

# Instalação

12. Coloque os parafusos especiais mas **NÃO** quebre a cabeça ainda.

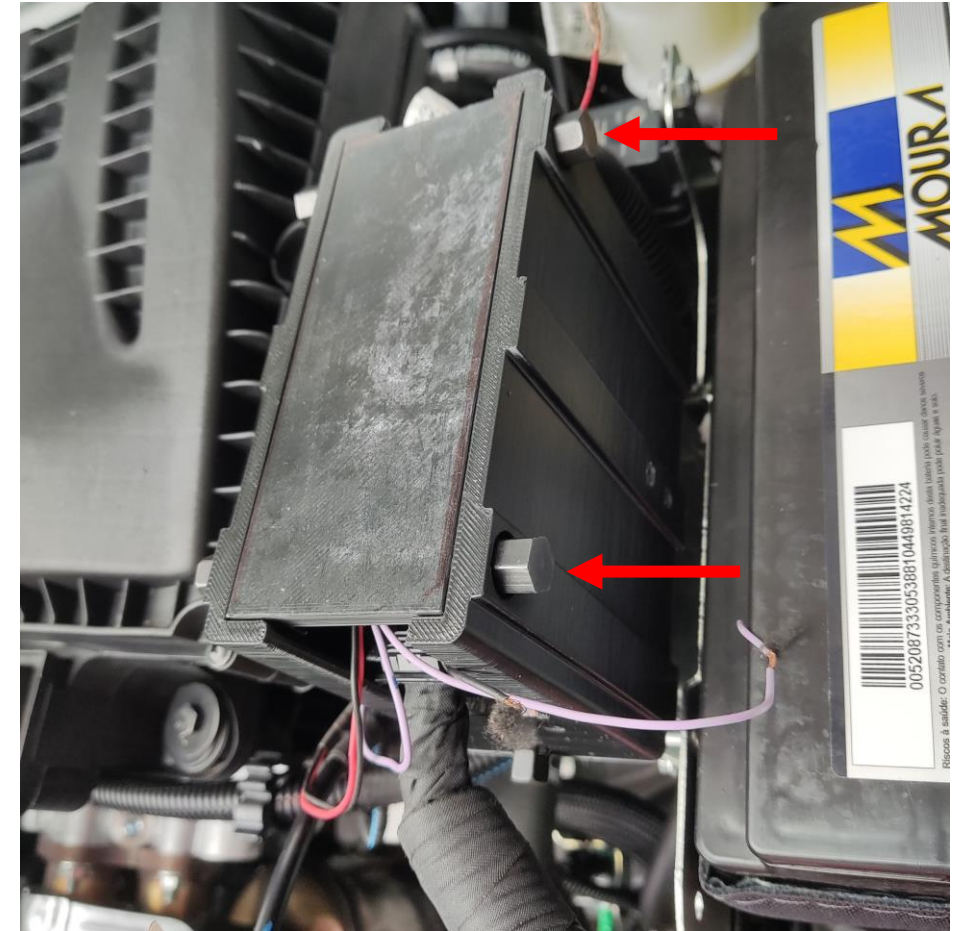
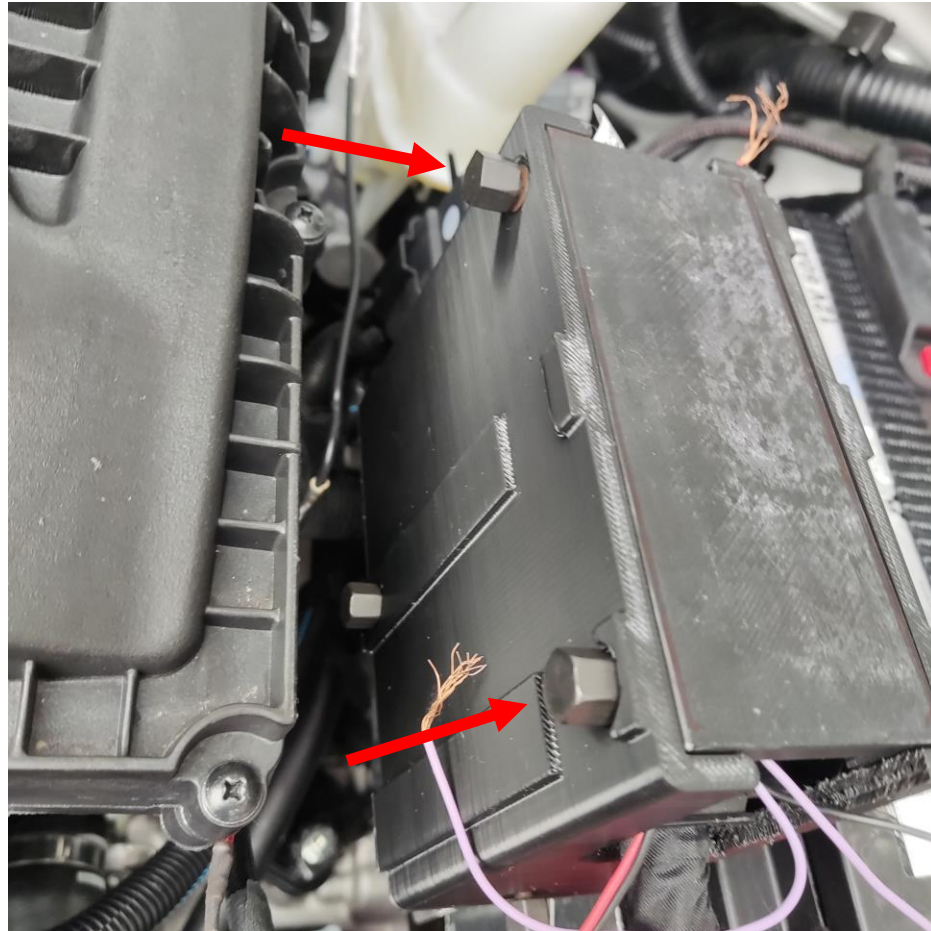

# Instalação

---



13. Coloque a bateria e ligue o veículo e veja se aparece alguma luz de defeito no painel. Caso apareça algum sinal de defeito **PARE**, e tente desconectar e reconectar os conectores do ECU.
14. Quando todos os problemas forem resolvidos, pode prosseguir com a instalação, quebrando os parafusos especiais.
- Obs 1. Para quebrá-los basta continuar com o aperto até o rompimento.
  - Obs 2. Tire todas as cabeças que foram quebradas dos parafusos, garanta que não fique nada no compartimento do motor.
  - Obs 3. Cuide para que nada seja perdido e não existam peças vibrando ou encostando em outras partes do veículo.

# Atenção

---



- Esse produto, bem como seu manual de instalação, foram desenvolvidos por profissionais técnicos;
- A SAFECAR não se responsabiliza por nenhum dano, seja físico ou financeiro, causado pelo uso incorreto do produto ou das instruções;
- Em caso de dúvida ou comentário, entre em contato conosco: [tecnico@safecar.net.br](mailto:tecnico@safecar.net.br)



# SAFECAR

ESPECIALISTA CONTRA CRIMES AUTOMOTIVOS

Safecar Brasil Importação, Exportação e Participações Ltda.  
Rua Eliseu de Oliveira, 40 – Cidade Monções – São Paulo – SP  
Tel. (11) 5505-1548  
[www.safecar.biz](http://www.safecar.biz)