

Guia de instalação SAFECAR – 287



SAFECAR

ESPECIALISTA CONTRA CRIMES AUTOMOTIVOS

Atenção



- A instalação deve ser feita somente por profissionais autorizados;
- Ligar o carro para garantir que não exista nenhuma luz indicando defeito no painel;
- Caso tenha alguma luz de defeito acesa, informe o cliente antes do início da instalação;
- Aguarde 15 minutos após o desligamento do veículo para iniciar o processo de instalação;
- Não desmonte qualquer peça do veículo que não apareça neste guia;
- Ao final da instalação devolva as chaves do veículo onde as pegou.

Componentes do Cofre Blindado

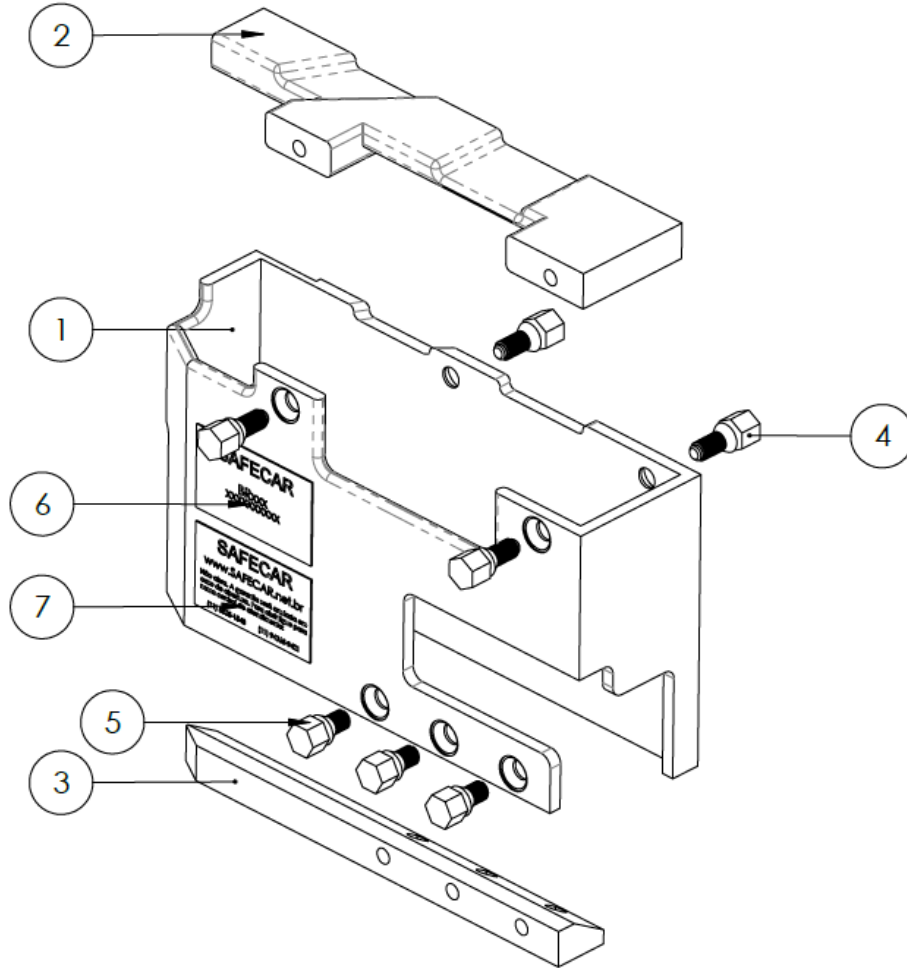

Nº DO ITEM	Nº DA PEÇA	QTD.
1	Cofre	1
2	Tampa	1
3	Trava	1
4	Parafuso especial	4
5	Parafuso especial pequeno	3
6	Etiqueta PRODUTO	1
7	Etiqueta SAFECAR	1

Instalação



1. Para acessar o módulo será necessário retirar o porta-luvas.



Instalação

2. Solte as laterais do porta-luvas.



Instalação

3. Retire o porta-luvas.



Instalação

4. Retire todos os chicotes indicados.

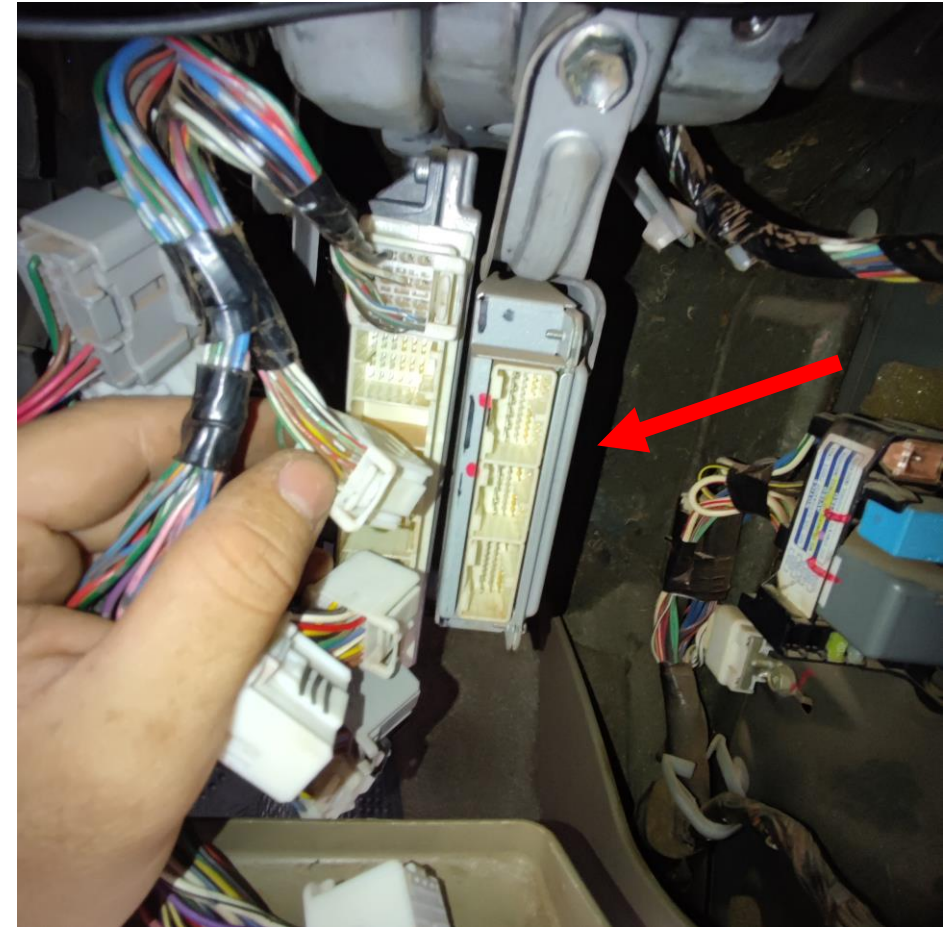
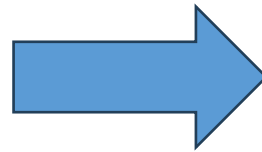
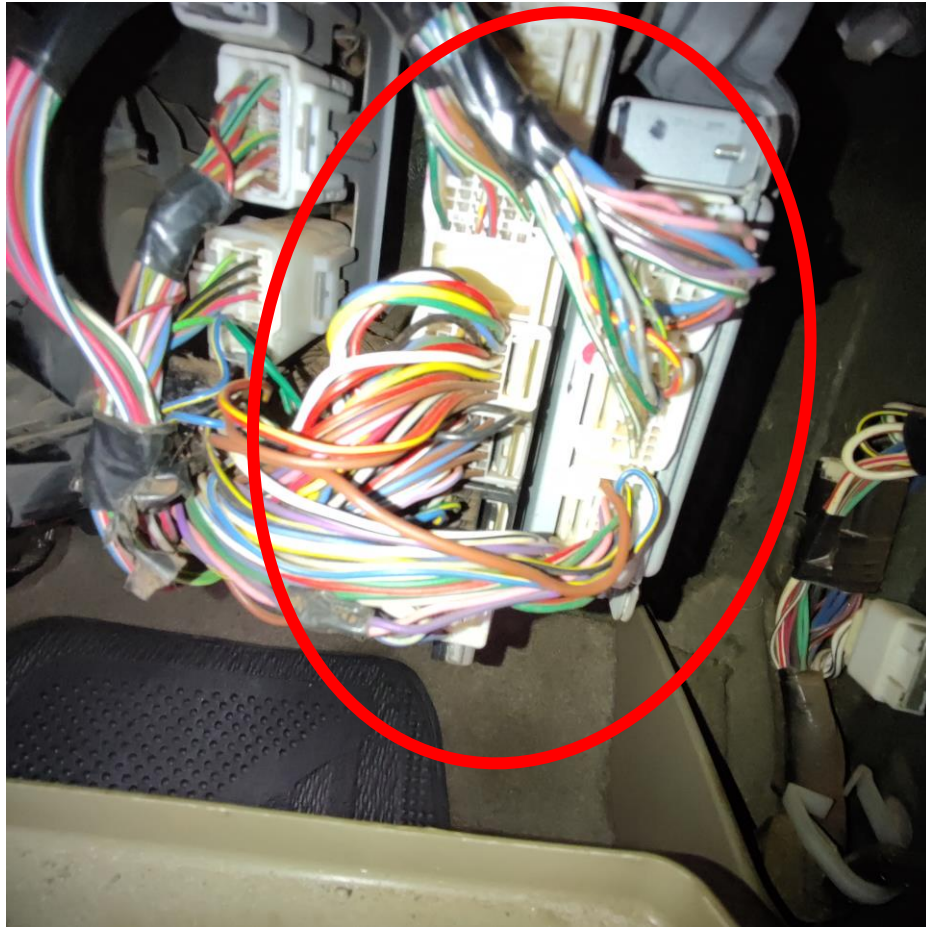

Instalação

5. Retire a presilha de fixação do chicote.

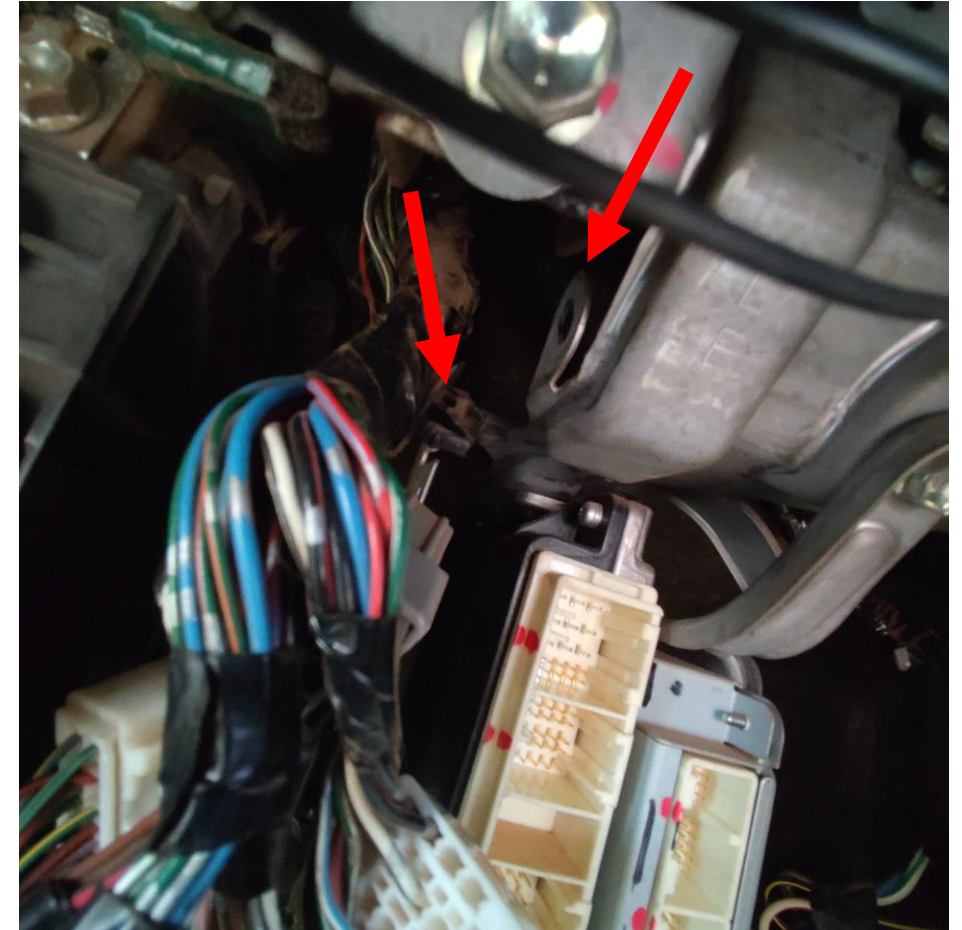
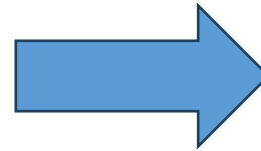
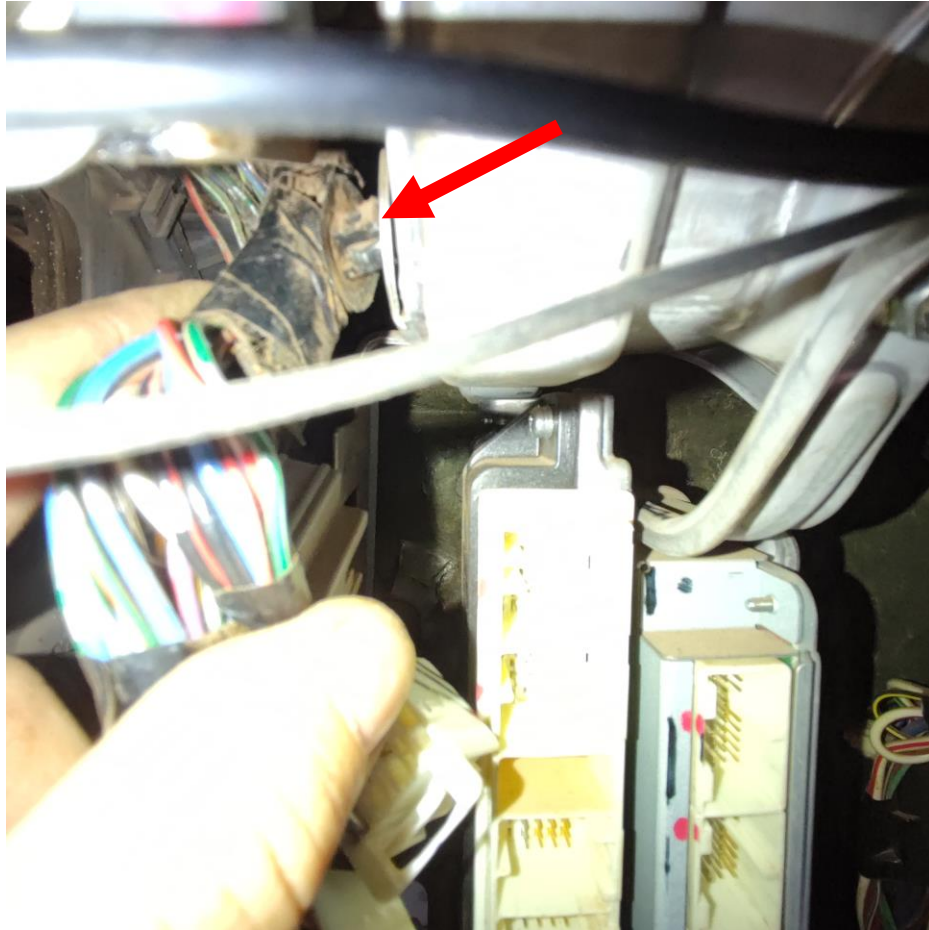

Instalação

6. Retire o parafuso indicado.

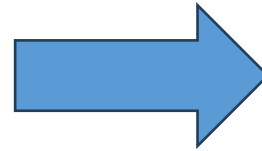

Instalação

7. Retire o parafuso indicado.

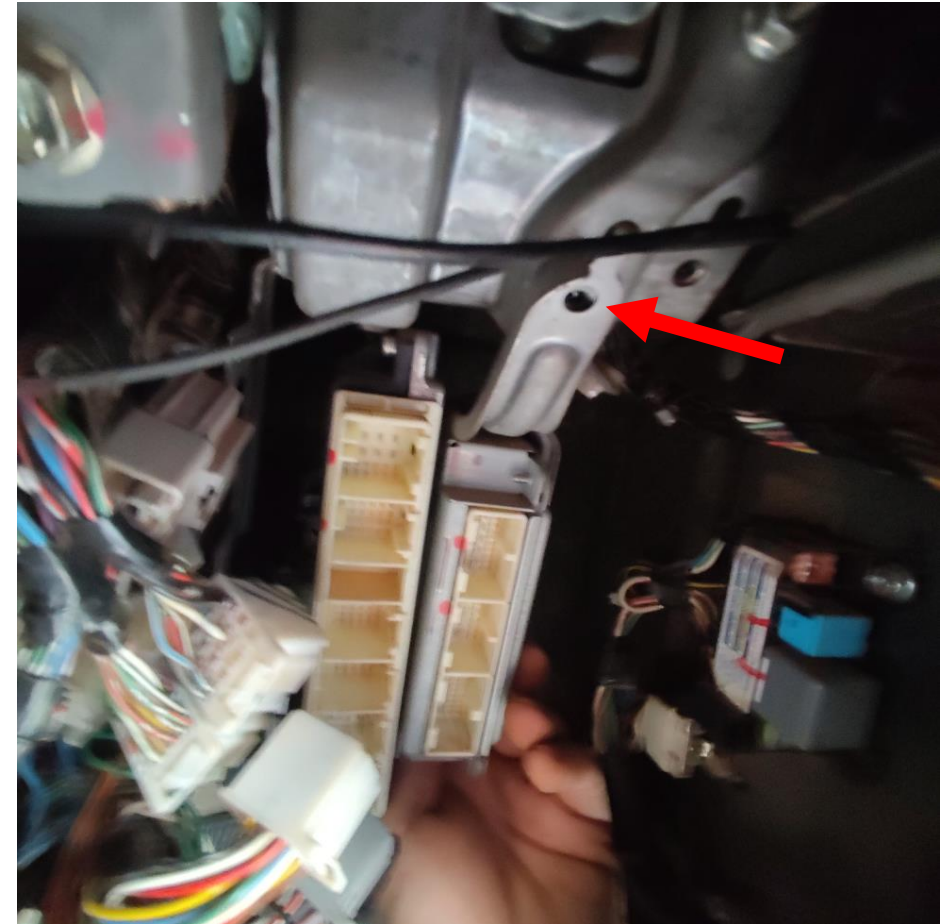
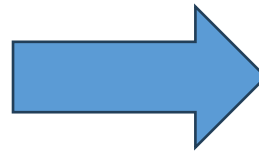

Instalação

8. Retire esse módulo lateral.

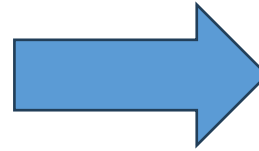
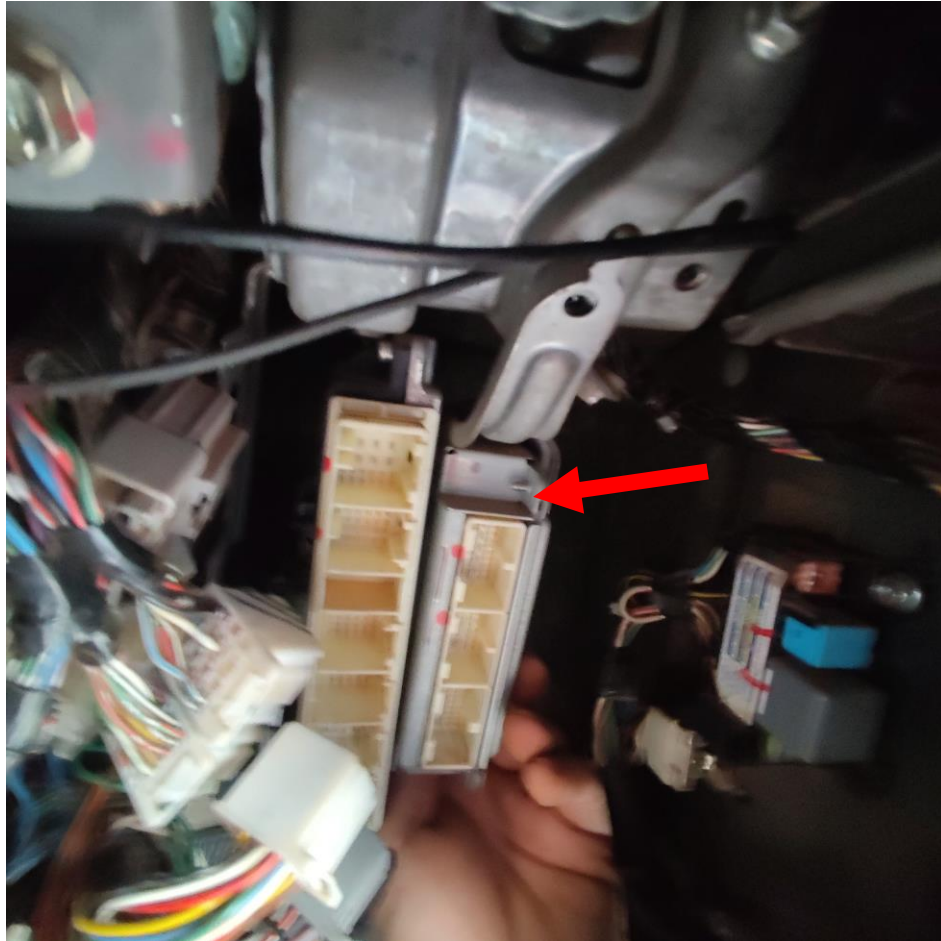

Instalação



9. Deixe esse módulo de lado por enquanto.



Instalação

10. Retire os 3 plugs do suporte.

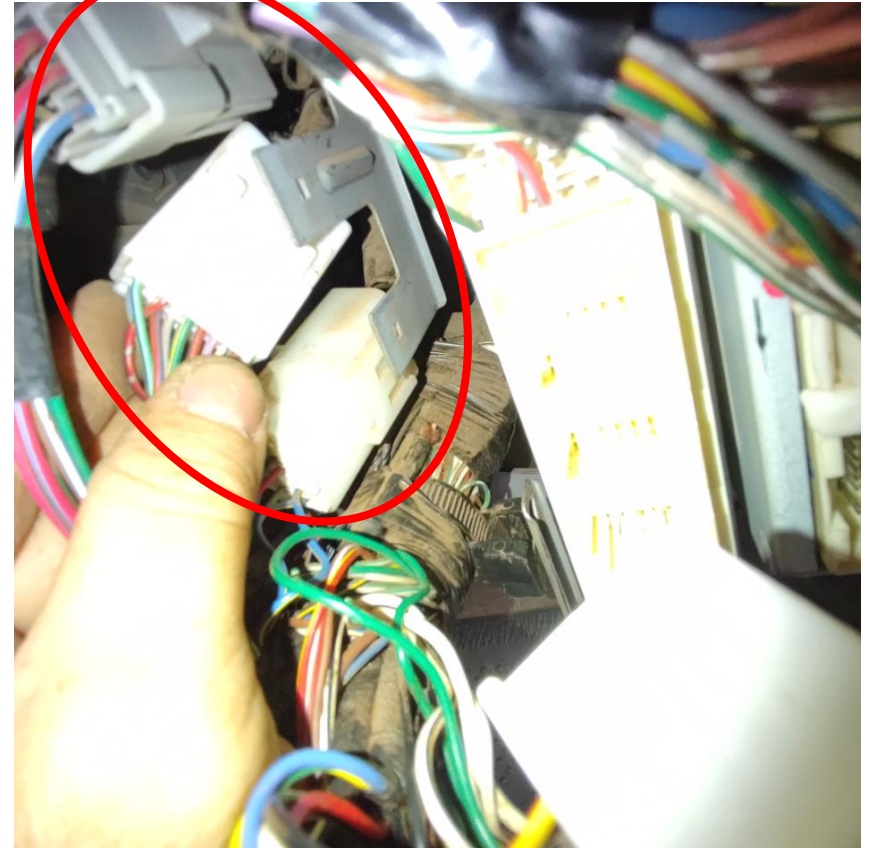
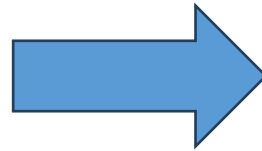
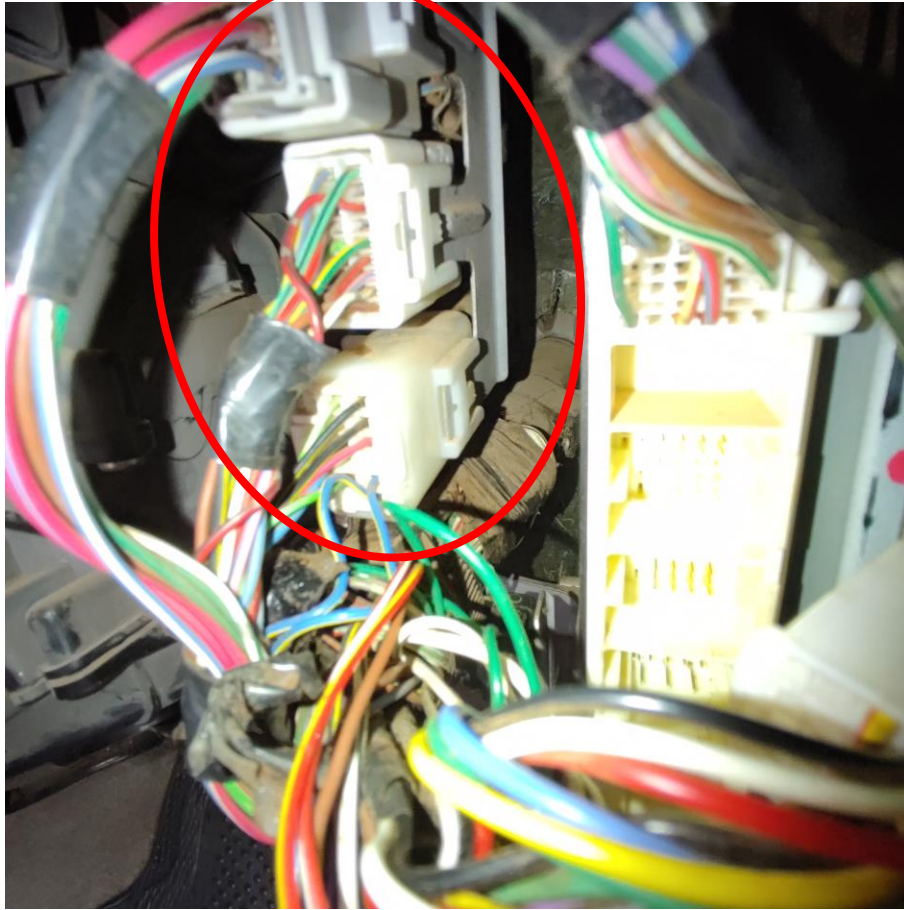

Instalação

11. Puxe para fora o porta copos.

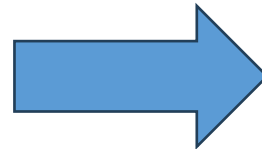

Instalação

12. Retire a porca indicada.

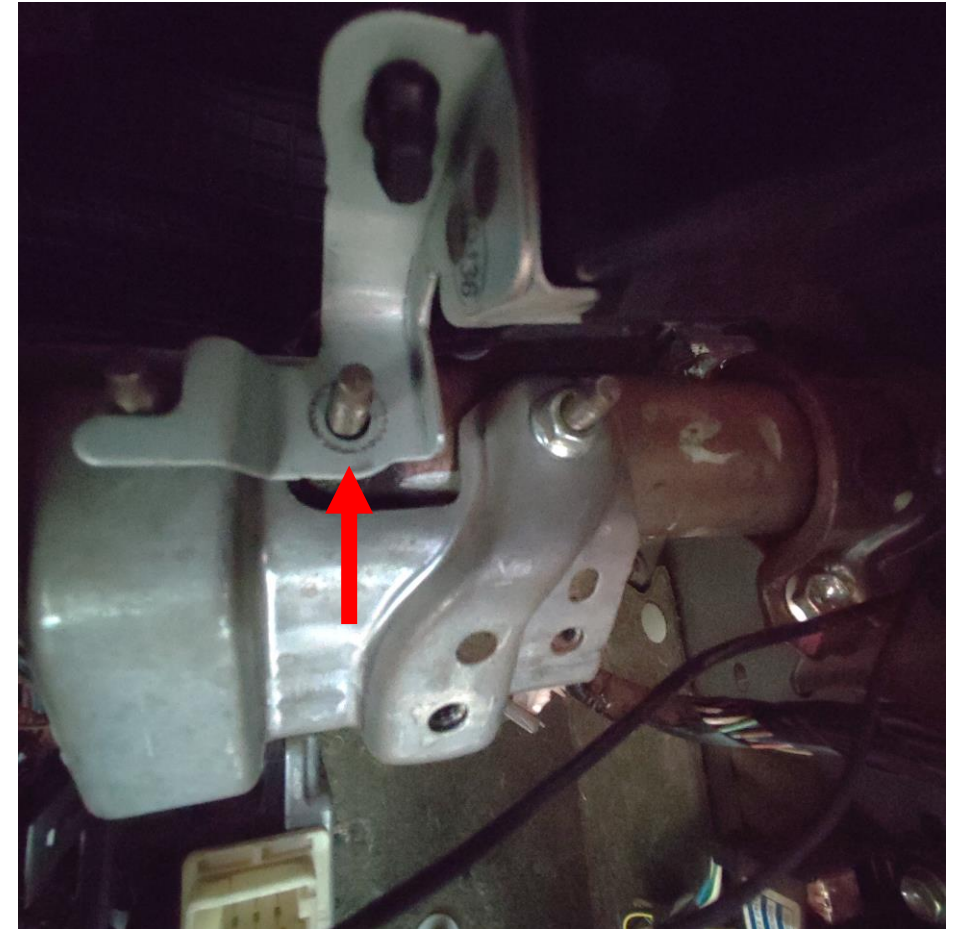
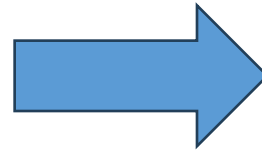
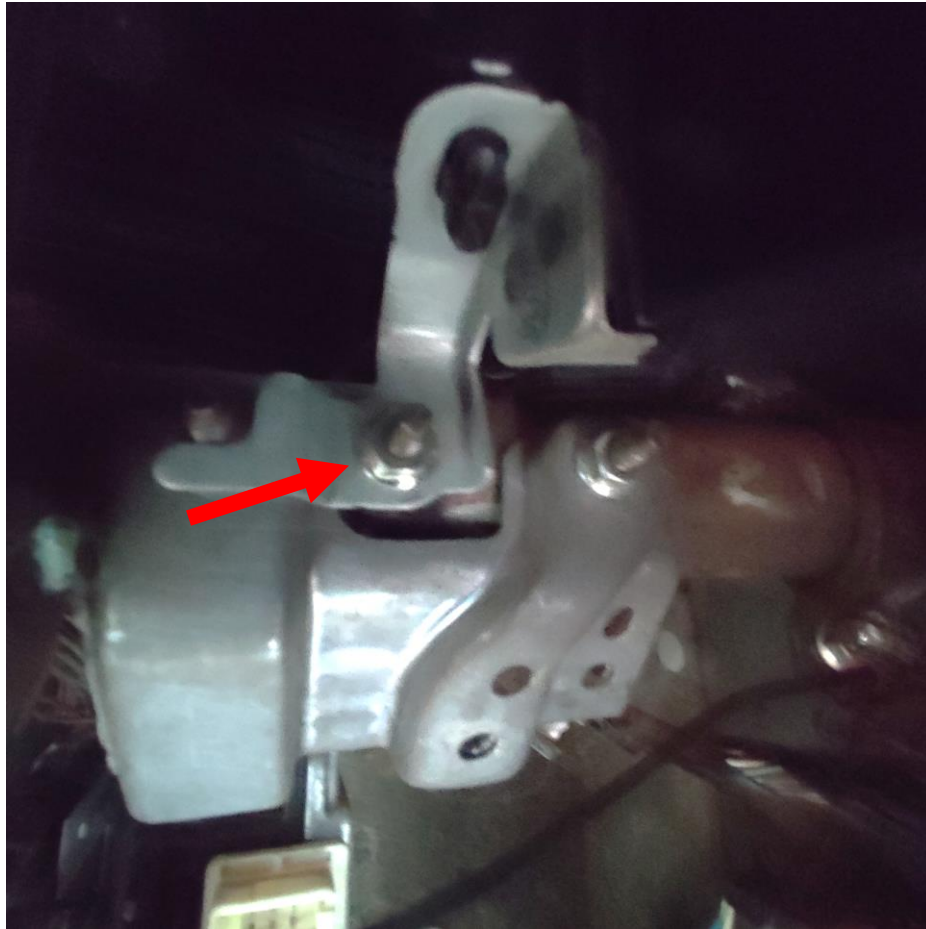

Instalação

13. Desloque o suporte para baixo.

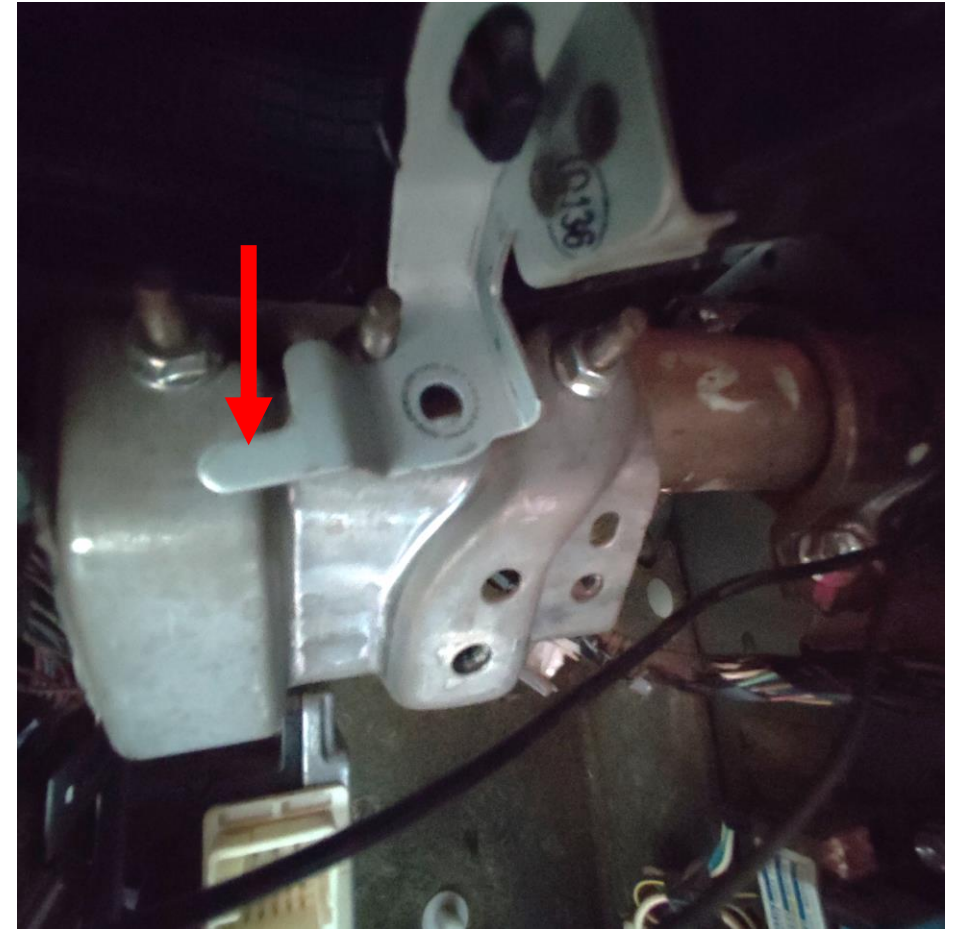
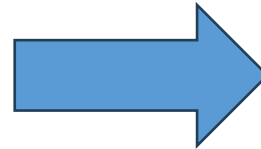
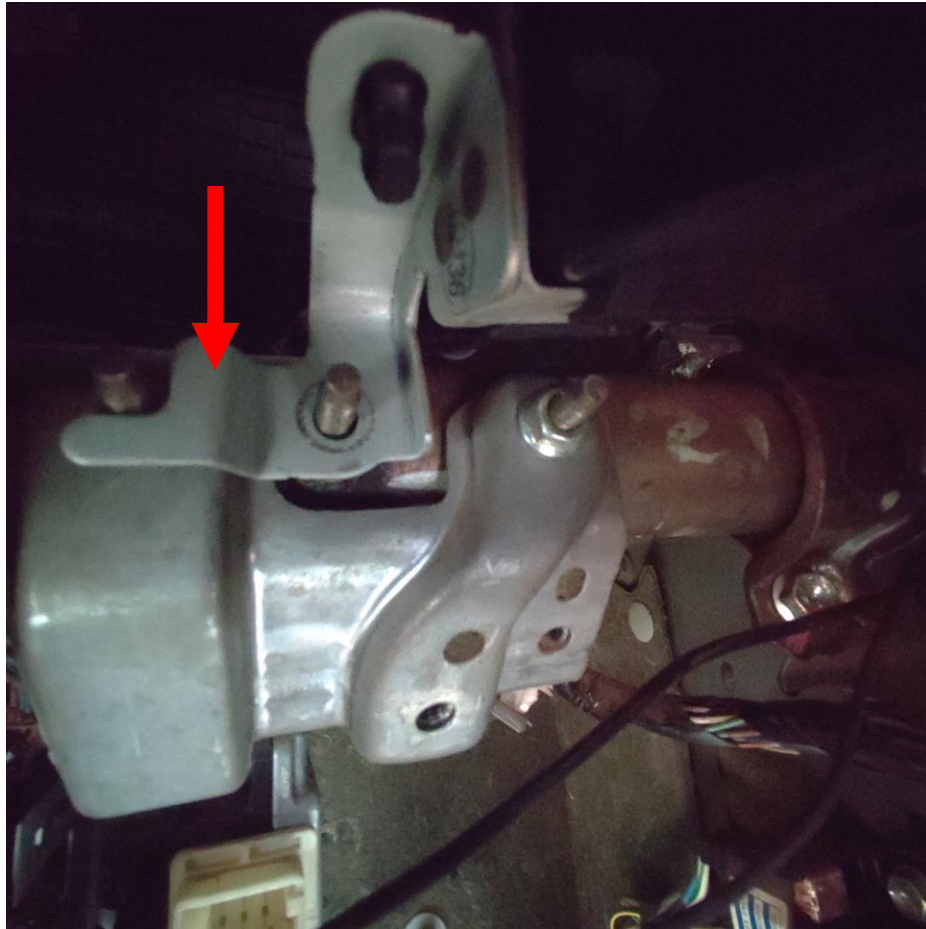

Instalação



14. Afaste um pouco a porca esquerda e retire a porca direita.

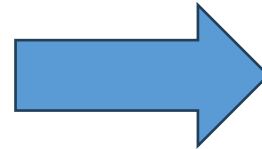
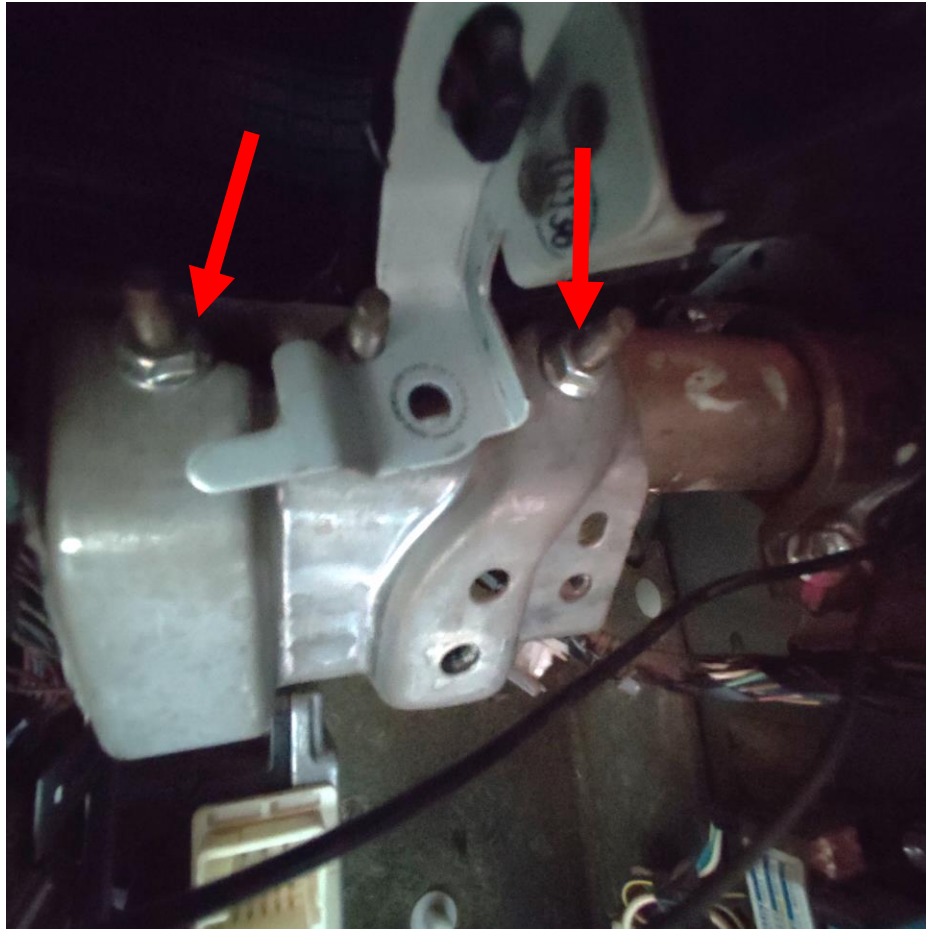

Instalação

15. Retire o parafuso indicado.

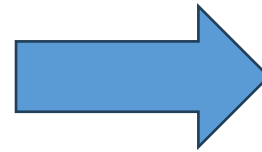

Instalação

16. Retire a presilha do chicote.

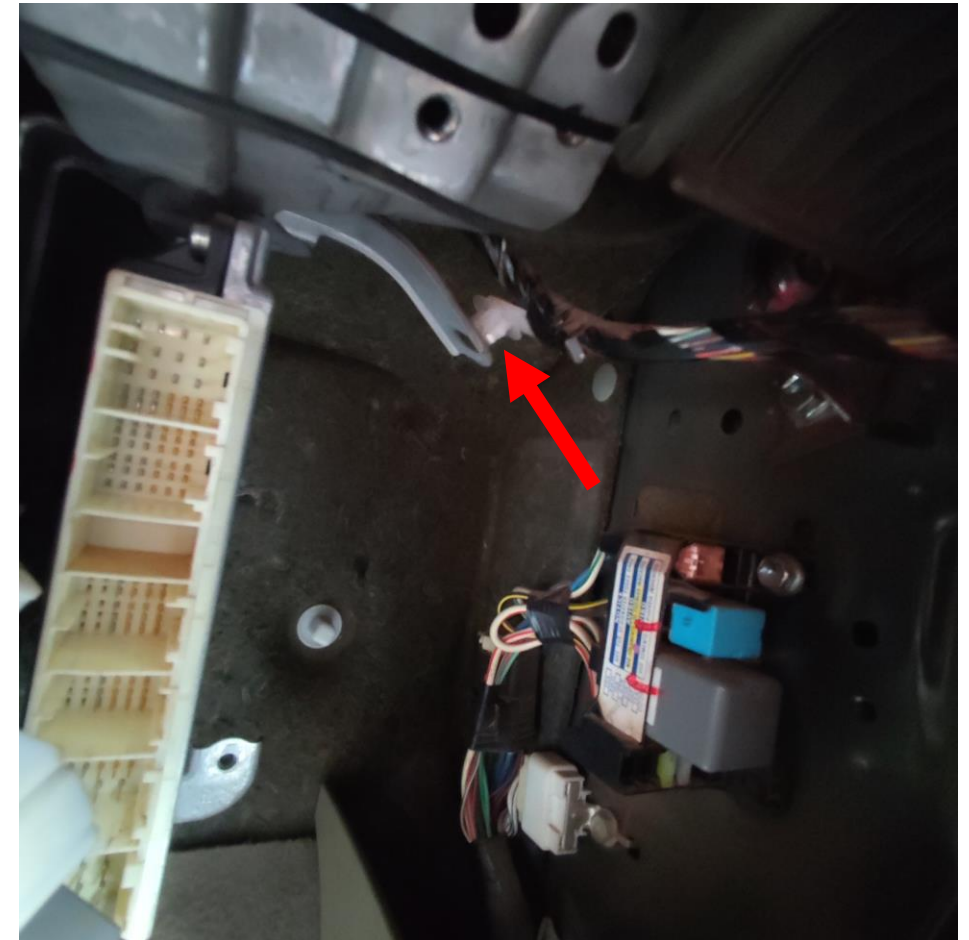
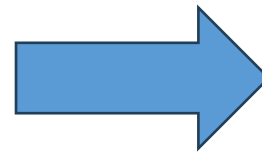

Instalação

17. Retire o módulo de injeção.

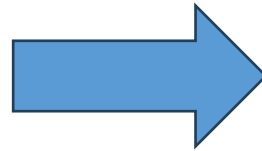

Instalação

18. Com o módulo solto, insira o cofre como indicado.

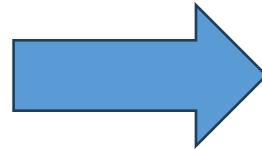

Instalação

19. Insira a trava em baixo do cofre se atentando a alinhar os furos.

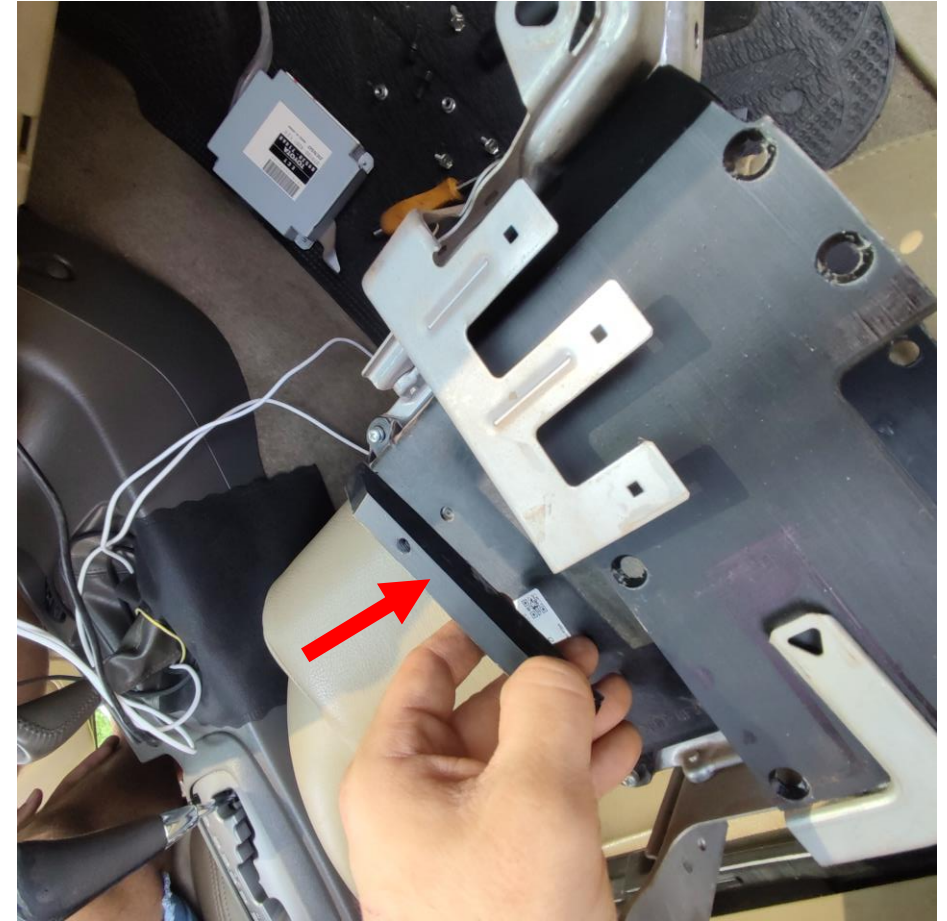
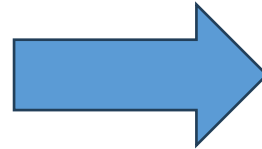

Instalação



20. Coloque os parafusos especiais mas **NÃO** quebre a cabeça ainda.



Instalação



21. Encaixe o módulo novamente.



Instalação

22. Coloque a presilha do chicote.

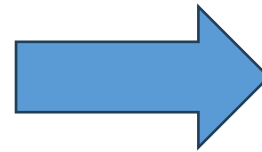
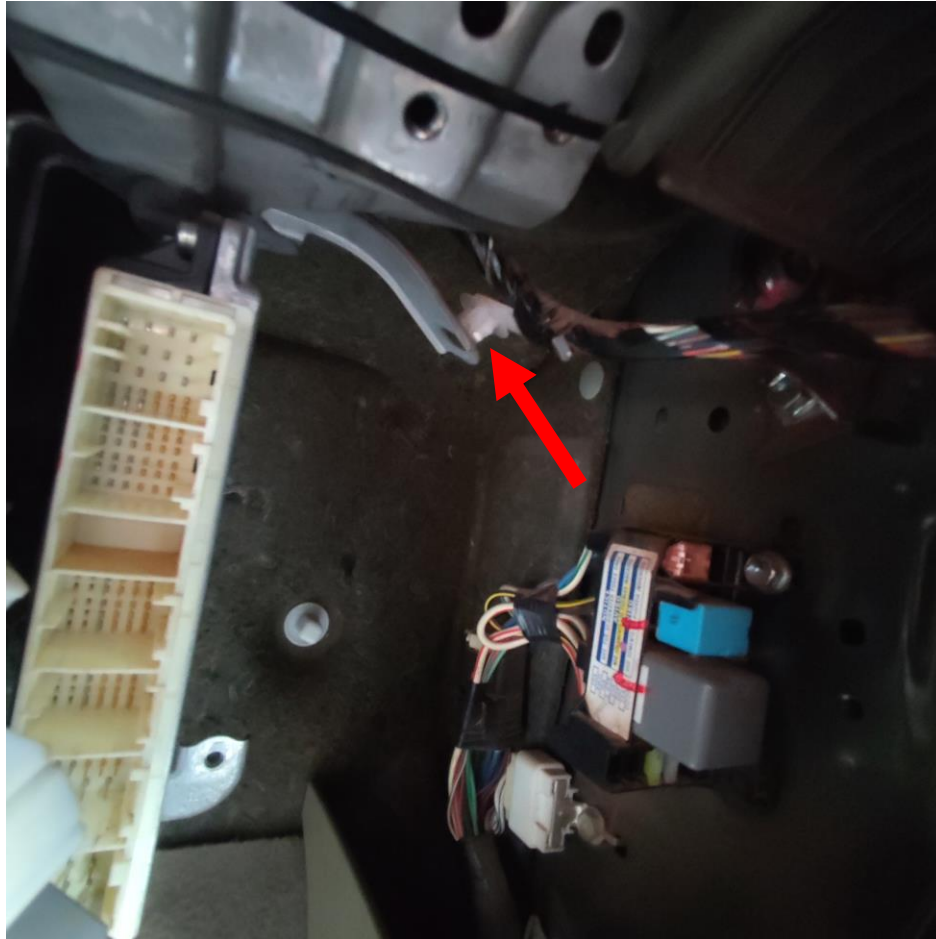

Instalação

23. Fixe o parafuso indicado.

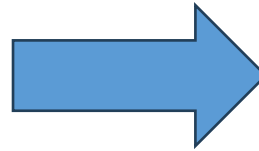

Instalação

24. Fixe novamente as porcas indicadas.

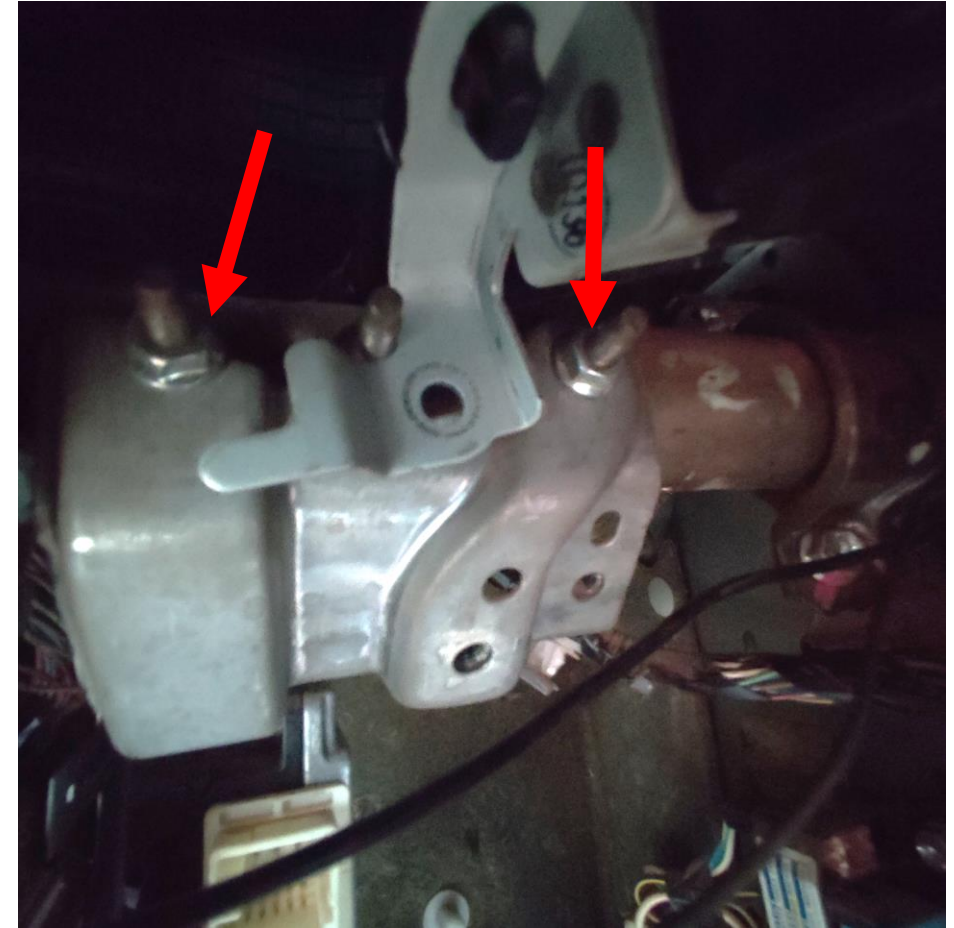
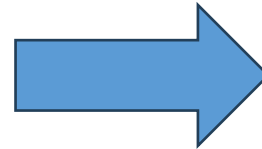

Instalação



25. Desloque o suporte para cima.

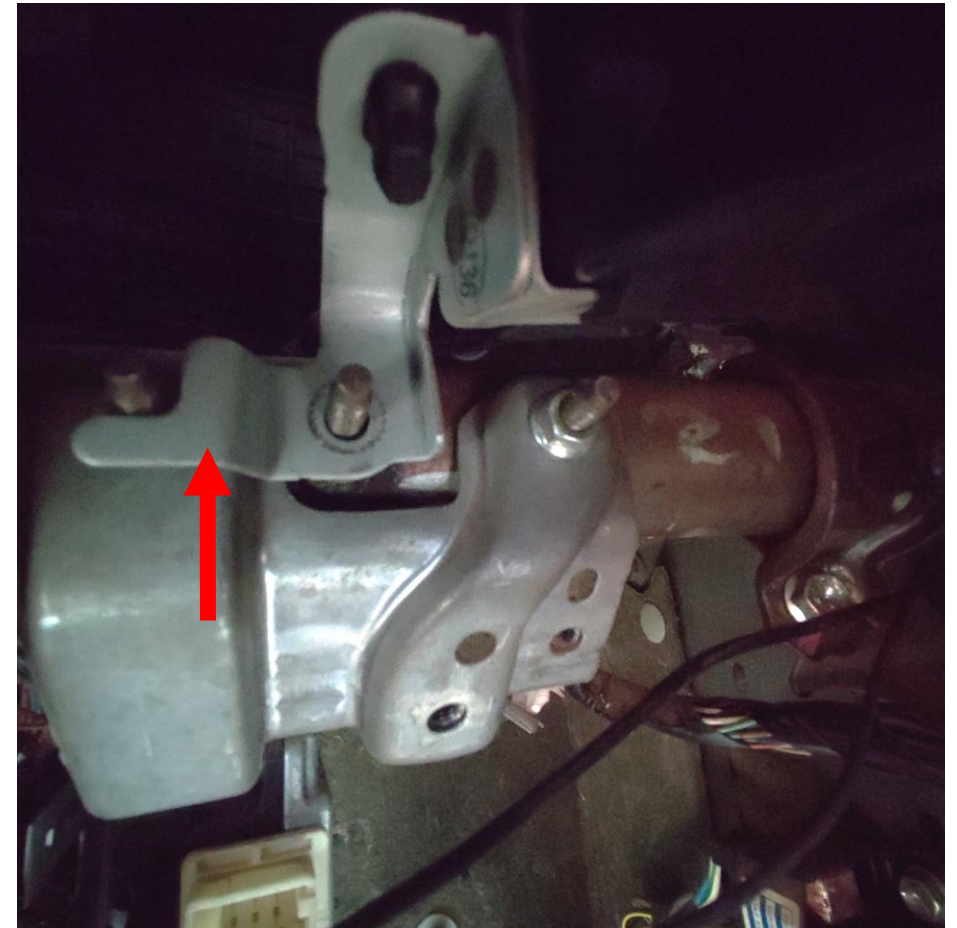
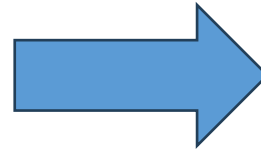
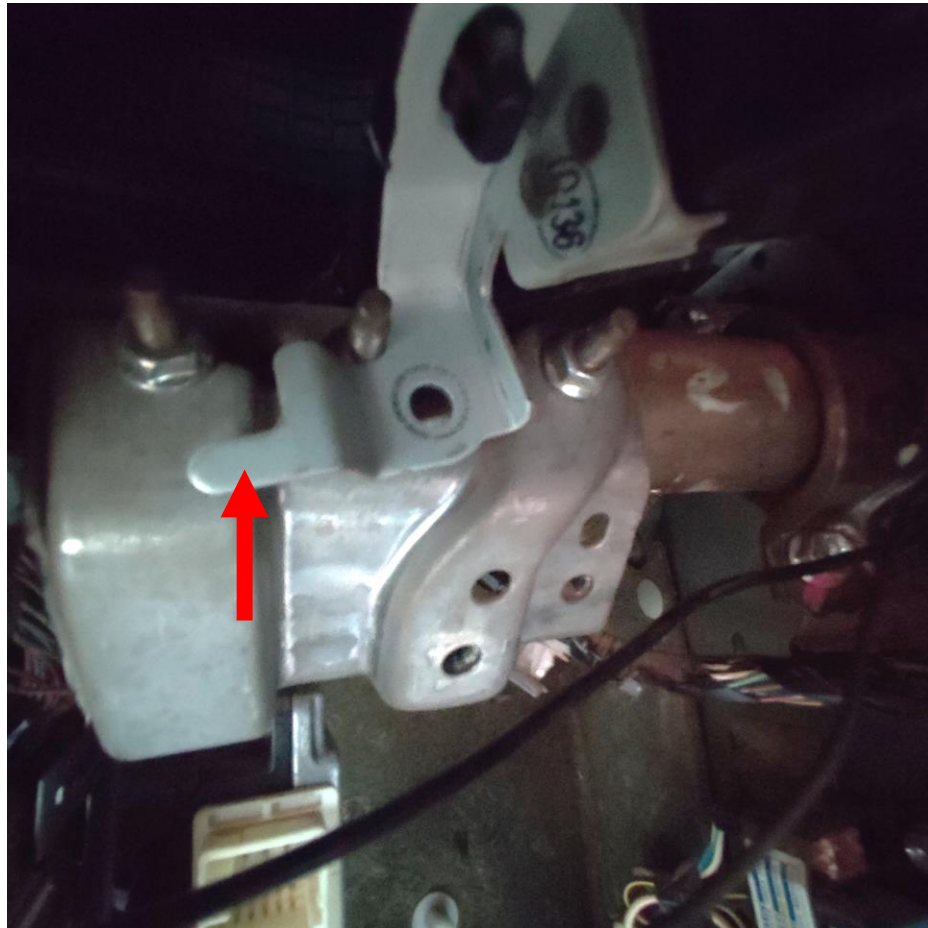

Instalação

26. Coloque a porca indicada.

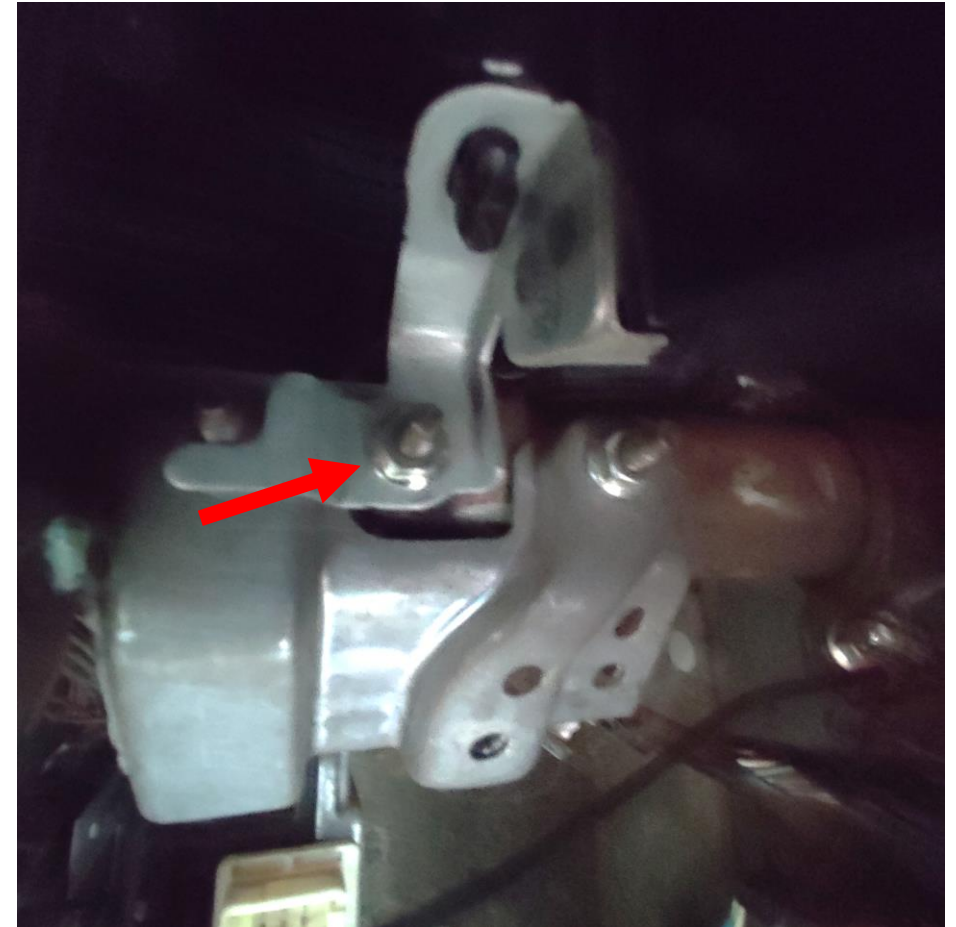
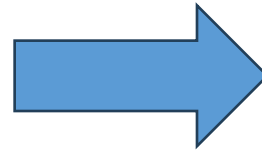
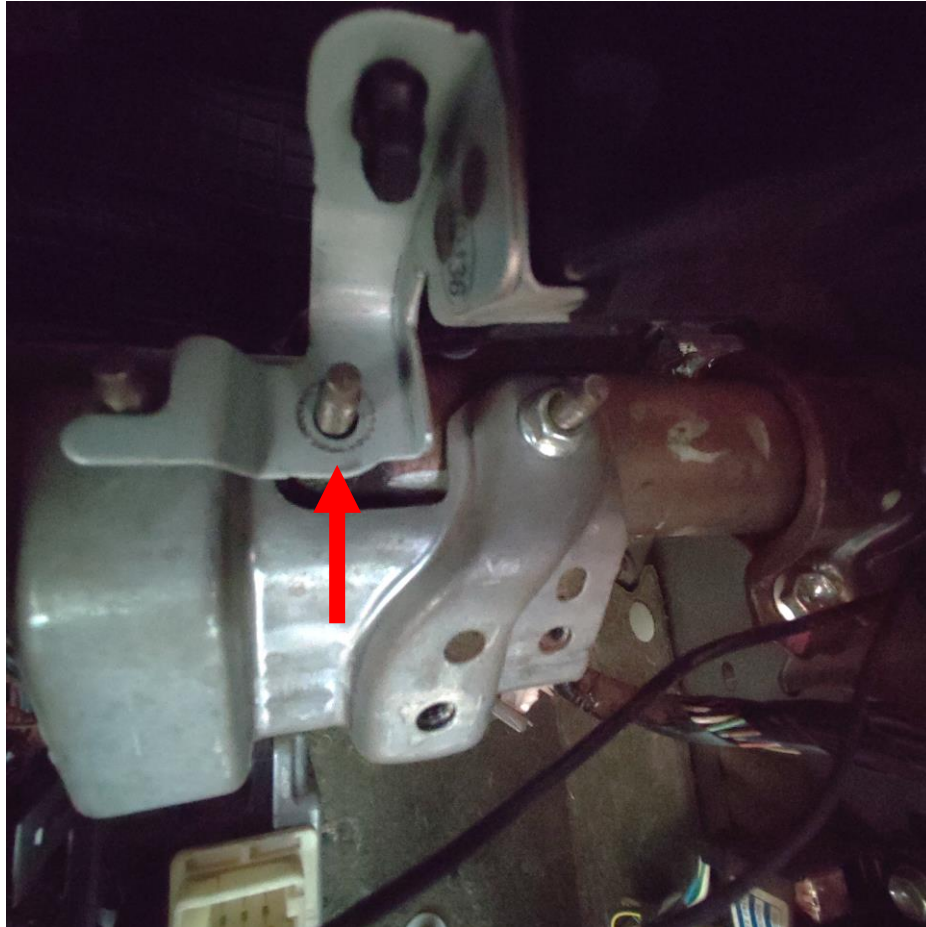

Instalação

27. Coloque o módulo.



Instalação

28. Encaixe o suporte do módulo e fixe com parafuso.

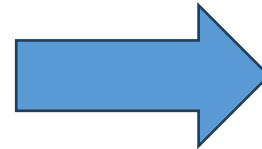

Instalação

29. Encaixe o suporte do módulo e fixe com parafuso.

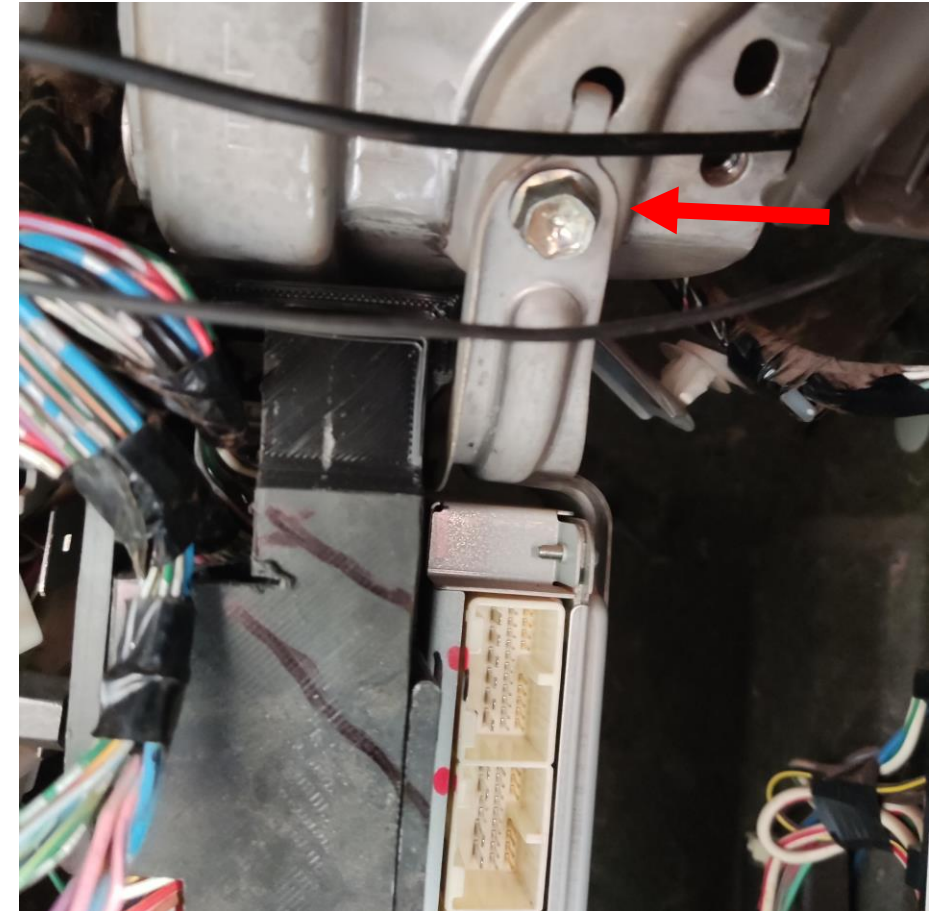
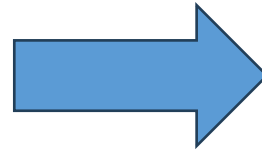
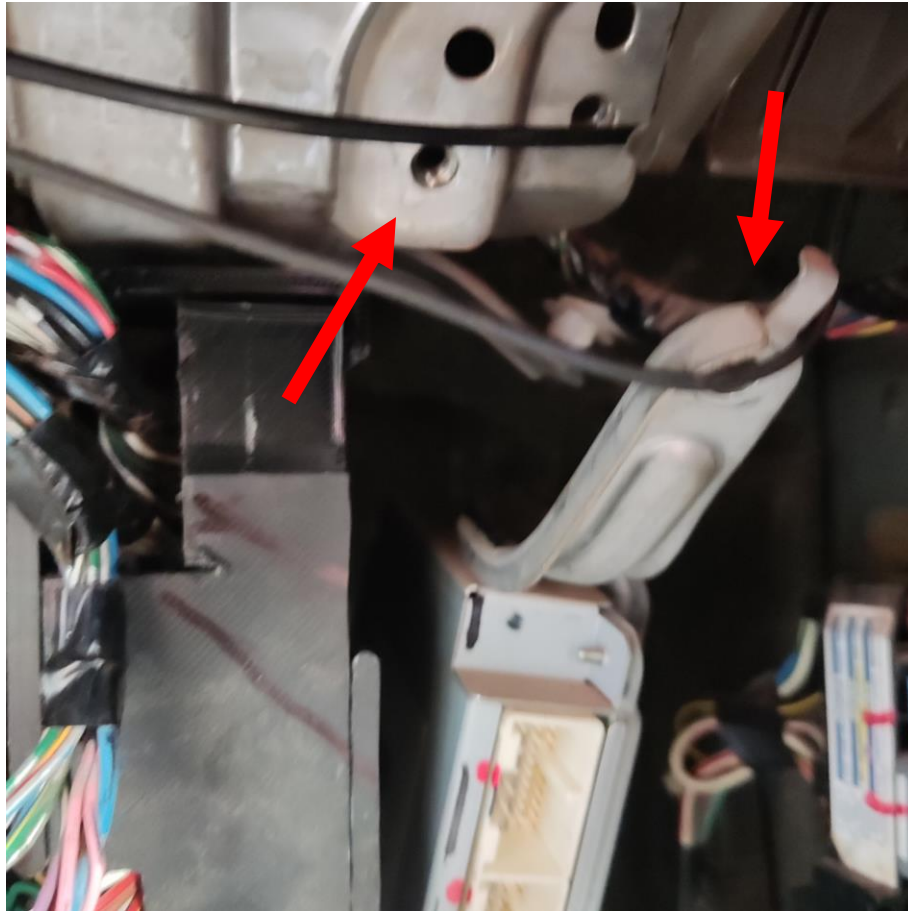

Instalação

30. Coloque a presilha de fixação do chicote.

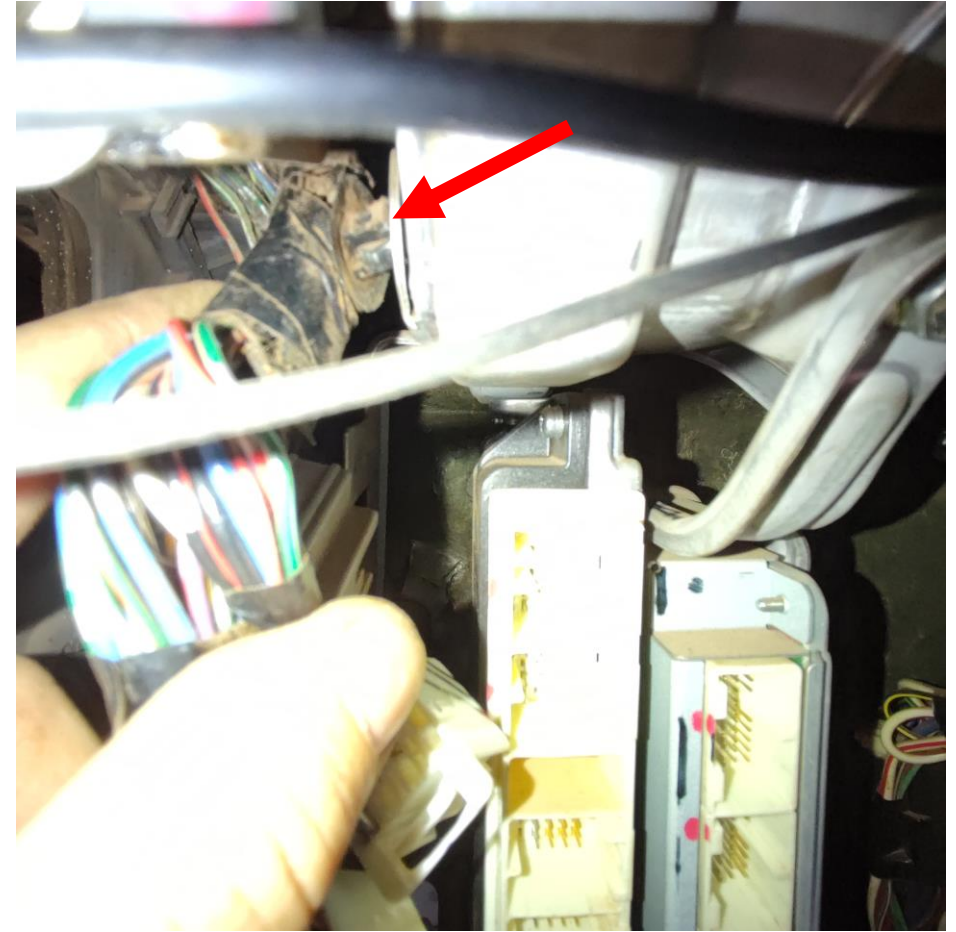
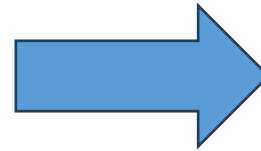
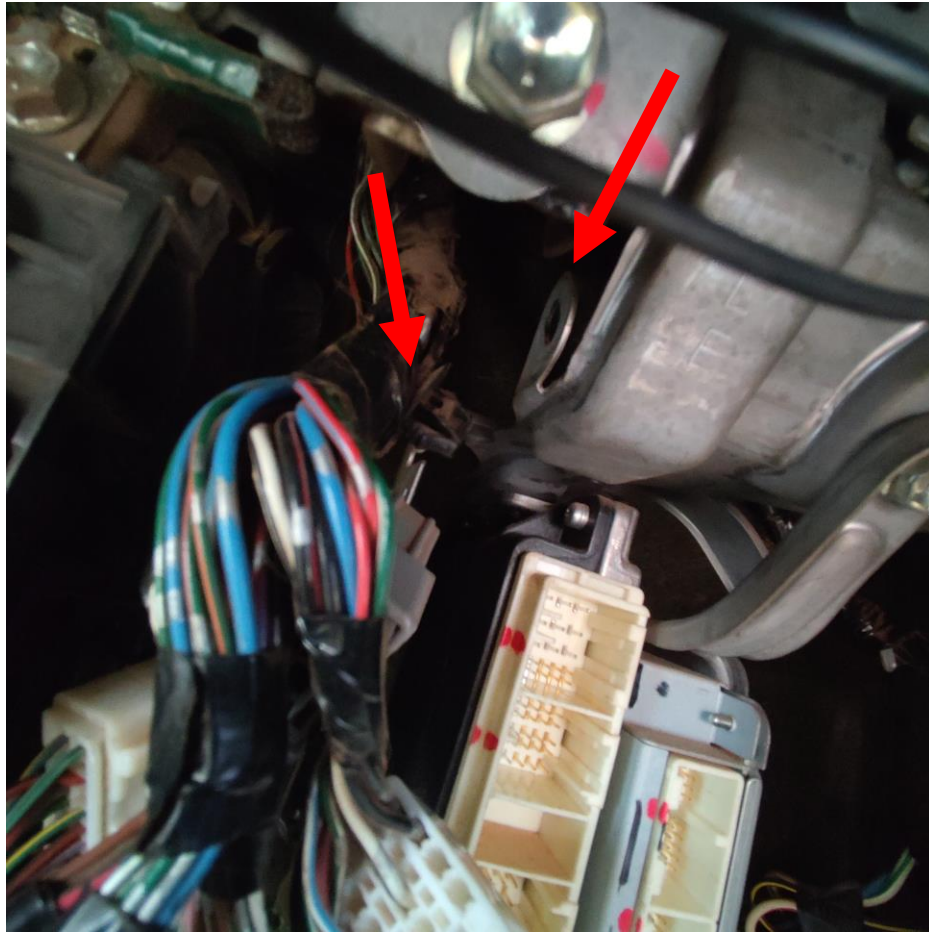

Instalação

31. Conecte os chicotes novamente no módulo.

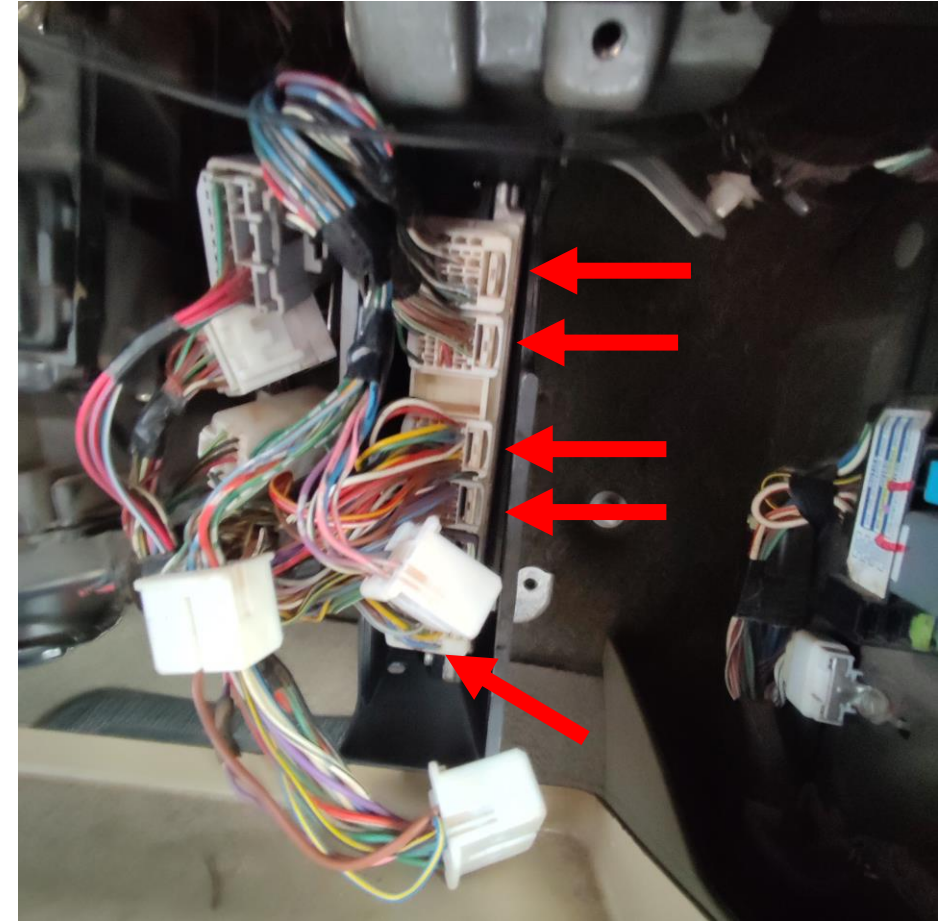
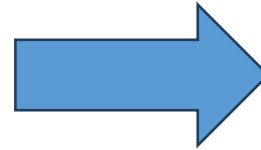

Instalação

32. Insira a tampa do cofre.

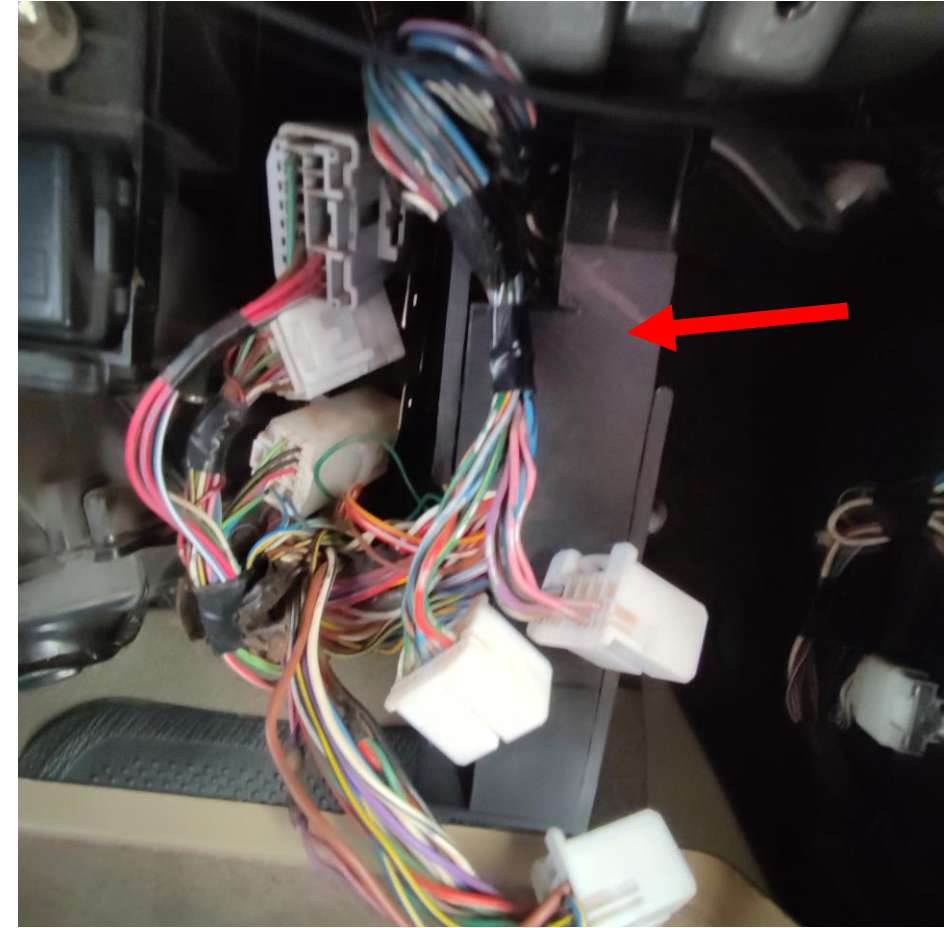
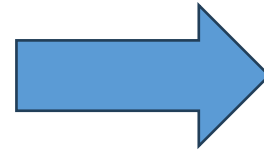
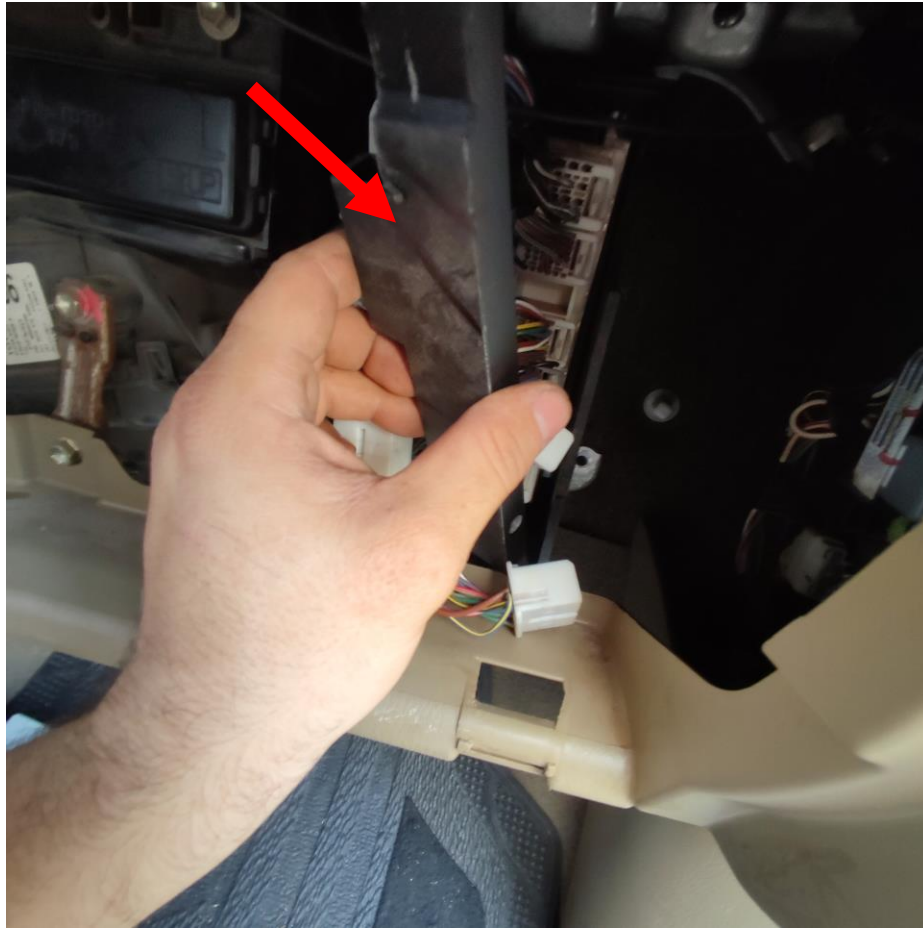

Instalação



33. Coloque os parafusos especiais mas **NÃO** quebre a cabeça ainda.

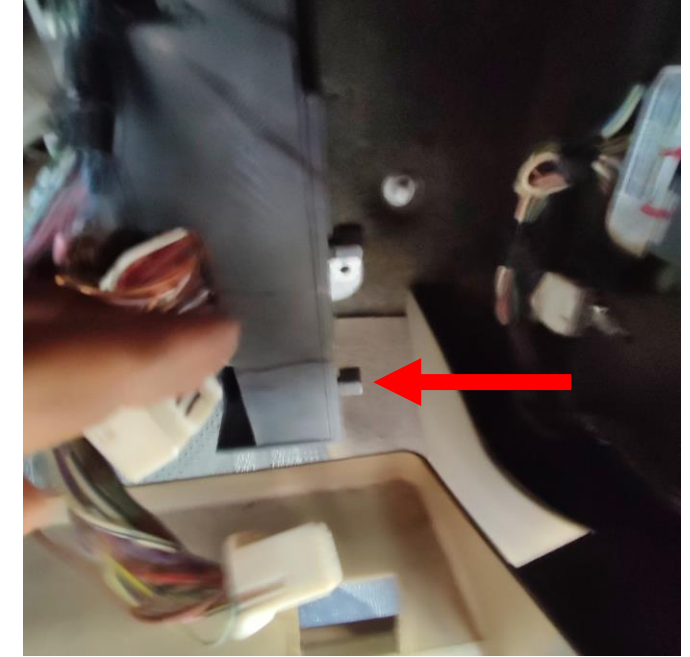
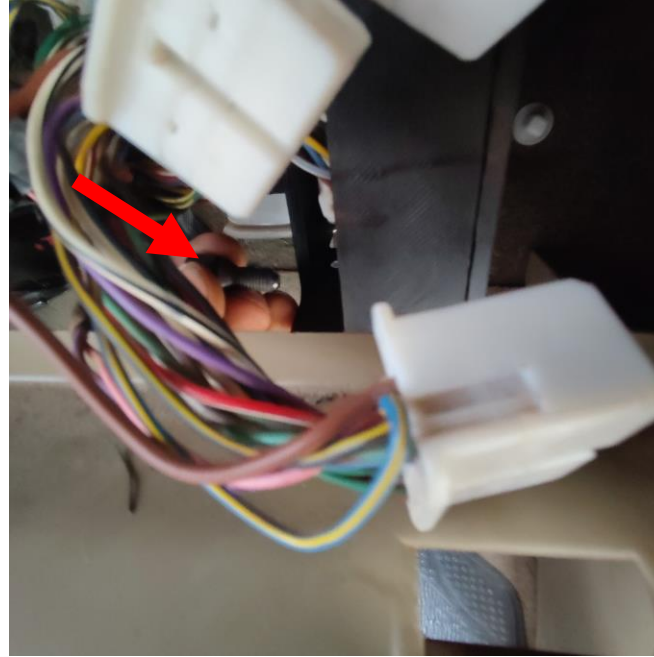

Instalação

34. Conecte os chicotes restantes.

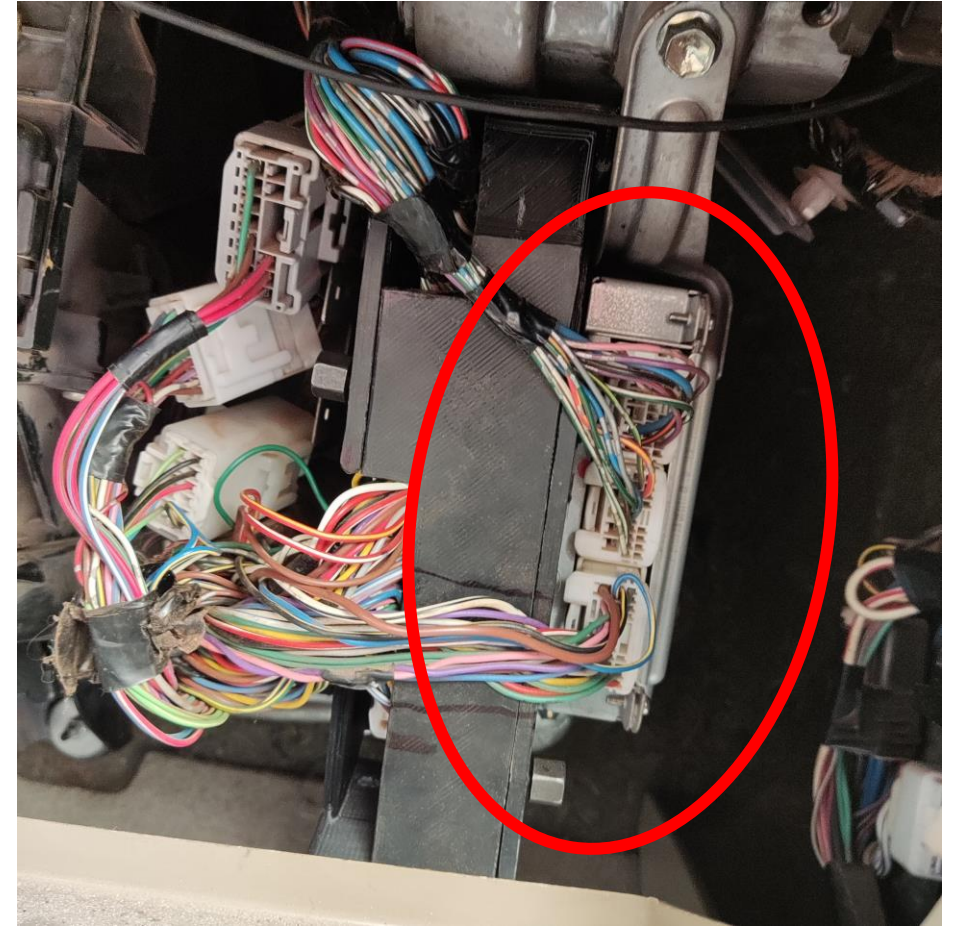
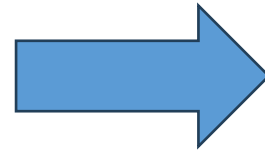
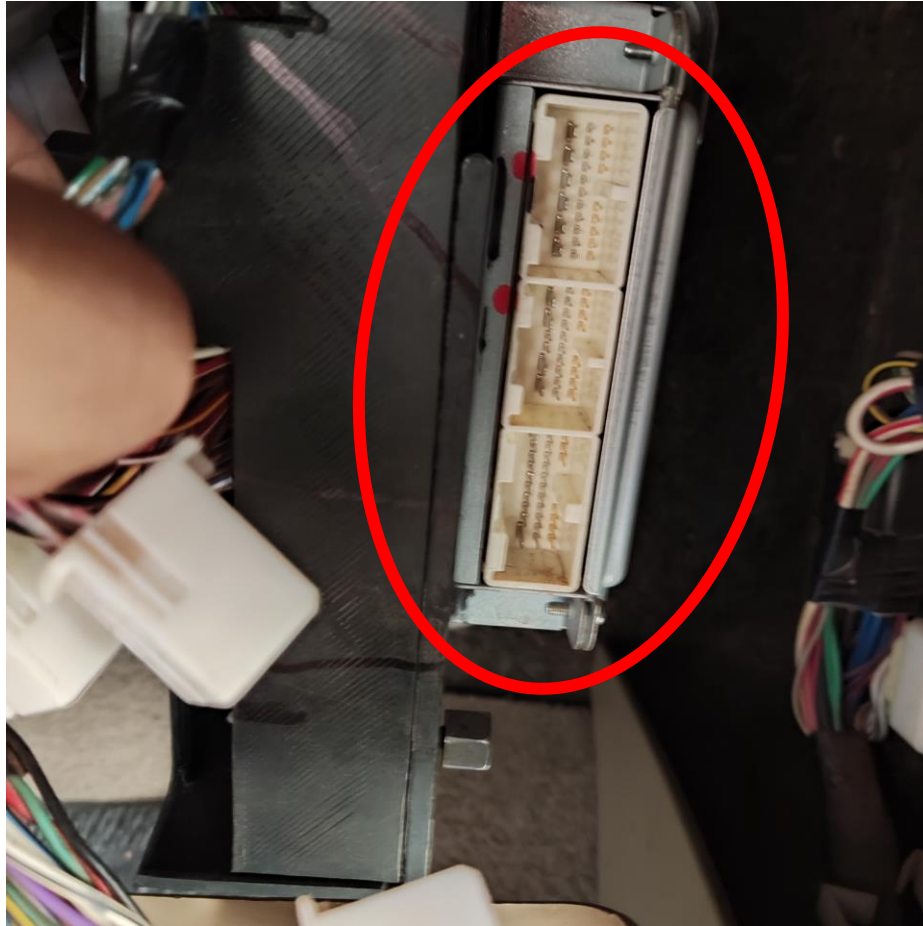

Instalação

35. Encaixe os 3 plugs no suporte.

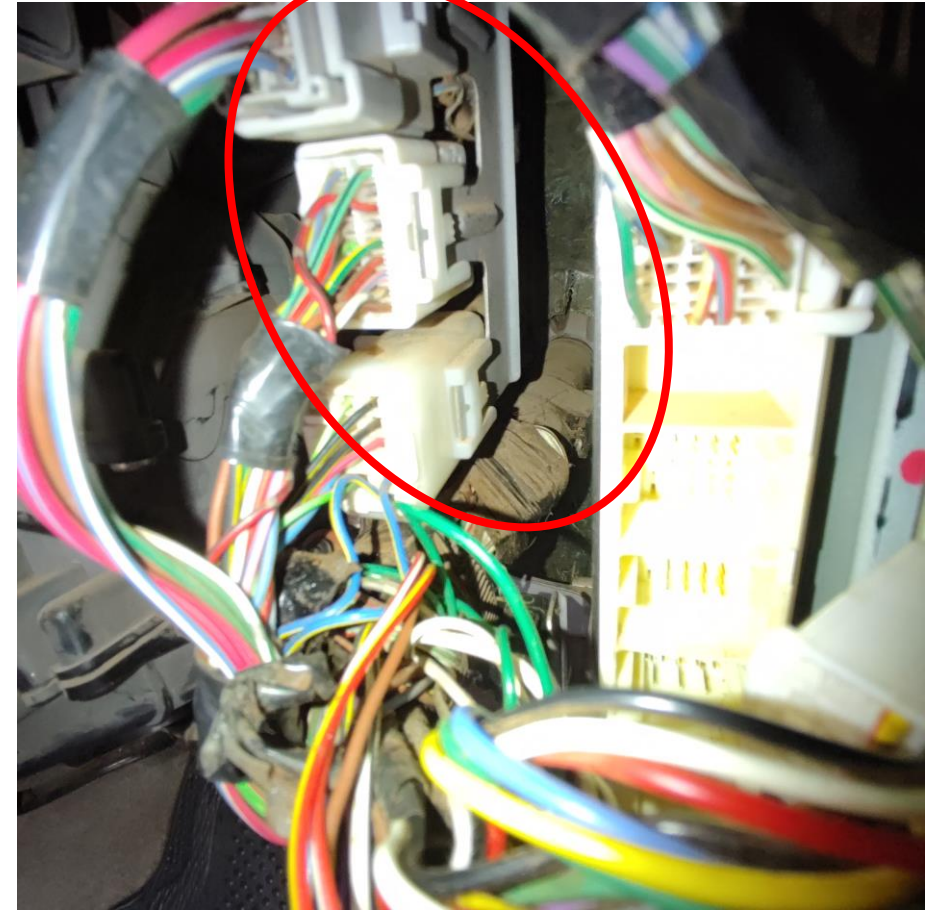
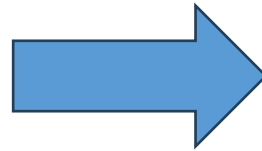
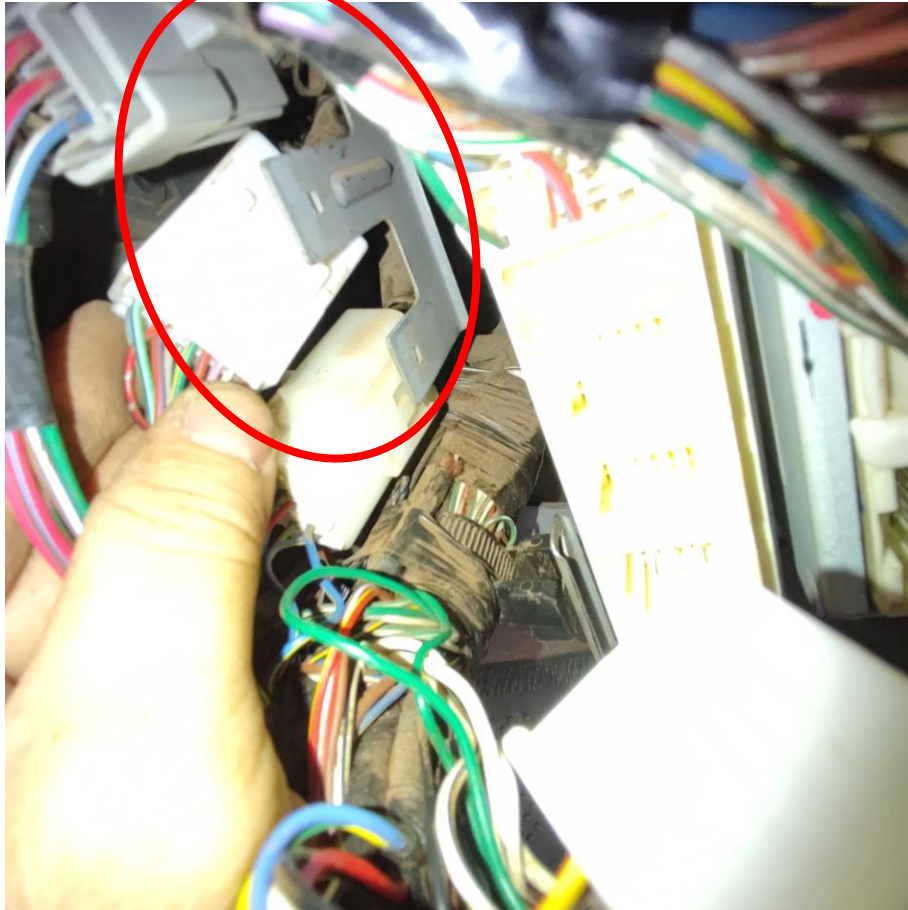

Instalação



36. Coloque a bateria e ligue o veículo e veja se aparece alguma luz de defeito no painel. Caso apareça algum sinal de defeito **PARE**, e tente desconectar e reconectar os conectores do ECU.

37. Quando todos os problemas forem resolvidos, pode prosseguir com a instalação, quebrando os parafusos especiais.

- Obs 1. Para quebrá-los basta continuar com o aperto até o rompimento.
- Obs 2. Tire todas as cabeças que foram quebradas dos parafusos, garanta que não fique nada no compartimento do motor.
- Obs 3. Cuide para que nada seja perdido e não existam peças vibrando ou encostando em outras partes do veículo.

Instalação



38. Coloque o porta-luvas.



Instalação

39. Encaixe as laterais do porta-luvas.



Atenção



- Esse produto, bem como seu manual de instalação, foram desenvolvidos por profissionais técnicos;
- A SAFECAR não se responsabiliza por nenhum dano, seja físico ou financeiro, causado pelo uso incorreto do produto ou das instruções;
- Em caso de dúvida ou comentário, entre em contato conosco: tecnico@safecar.net.br



SAFECAR

ESPECIALISTA CONTRA CRIMES AUTOMOTIVOS

Safecar Brasil Importação, Exportação e Participações Ltda.
Rua Eliseu de Oliveira, 40 – Cidade Monções – São Paulo – SP
Tel. (11) 5505-1548
www.safecar.biz